

NOKIA
CONNECTING PEOPLE

User Guide



Nokia 3595

User Guide

What information is needed?	Numbers	Where is the number?
My number		Wireless service provider
Voice mail number		Wireless service provider
Wireless provider's number		Wireless service provider
Wireless provider's customer care		Wireless service provider
Model number	3595	Label on back of phone (under battery)
Phone type number	NPM-10 NPM-10X	Label on back of phone (under battery)
International mobile equipment identity (IMEI)		Label on back of phone (under battery). See "Find information about your phone" on page 7.

LEGAL INFORMATION

Part No. 9230479, Issue No. 2

Copyright © 2004 Nokia. All rights reserved.

Nokia, Nokia Connecting People, Air Glide, Bowling, Backgammon, Sky Diver, Nokia 3595, Xpress-on, and the Nokia Original Enhancements logos are trademarks or registered trademarks of Nokia Corporation. Other company and product names mentioned herein may be trademarks or trade names of their respective owners.

Printed in Canada 04/04

US Patent No 5818437 and other pending patents. T9 text input software

Copyright © 1999-2003. Tegic Communications, Inc. All rights reserved.



Includes RSA BSAFE cryptographic or security protocol software from RSA Security.



POWERED

Java is a trademark of Sun Microsystems, Inc.

The information contained in this user guide was written for the Nokia 3595 product. Nokia operates a policy of ongoing development. Nokia reserves the right to make changes to any of the products described in this document without prior notice.

UNDER NO CIRCUMSTANCES SHALL NOKIA BE RESPONSIBLE FOR ANY LOSS OF DATA OR INCOME OR ANY SPECIAL, INCIDENTAL, AND CONSEQUENTIAL OR INDIRECT DAMAGES HOWSOEVER CAUSED. THE CONTENTS OF THIS DOCUMENT ARE PROVIDED "AS IS." EXCEPT AS REQUIRED BY APPLICABLE LAW, NO WARRANTIES OF ANY KIND, EITHER EXPRESS OR IMPLIED, INCLUDING, BUT NOT LIMITED TO, THE IMPLIED WARRANTIES OF MERCHANTABILITY AND FITNESS FOR A PARTICULAR PURPOSE, ARE MADE IN RELATION TO THE ACCURACY AND RELIABILITY OR CONTENTS OF THIS DOCUMENT. NOKIA RESERVES THE RIGHT TO REVISE THIS DOCUMENT OR WITHDRAW IT AT ANY TIME WITHOUT PRIOR NOTICE.

EXPORT CONTROLS

This device may contain commodities, technology, or software that may only be exported in accordance with the U. S. Export Administration regulations. Diversion contrary to U.S. or Canadian law is prohibited.

FCC/INDUSTRY CANADA NOTICE

Your device may cause TV or radio interference (for example, when using a telephone in close proximity to receiving equipment). The FCC or Industry Canada can require you to stop using your telephone if such interference cannot be eliminated. If you require assistance, contact your local service facility. This device complies with part 15 of the FCC rules. Operation is subject to the condition that this device does not cause harmful interference.

Manufactured or sold under one or more of the following US Patents.

4868846	4945633	5001372	5053928	5083240	5101175
5124672	5151946	5152004	5173927	5212834	5230091
5241583	5266782	5271056	5311151	5317283	5331638
5335362	5341149	5353328	5371481	5378935	5384782
5390223	5392460	5396657	5400949	5408504	5416435
5430740	5442521	5444816	5446364	5446422	5477422
5479476	5487084	5526366	5534878	5548616	5551067
5553125	5557639	5565821	5566201	5570369	5581244
5594797	5600708	5606548	5613235	5625274	5640395
5664053	5675611	5677620	5692032	5697074	5699482
5701392	5722074	5729541	5760568	5787341	5794142
5797102	5802465	5805301	5809413	5819165	5821891
5822366	5827082	5835858	5835889	5839101	5842141
5844884	5845219	5850607	5857151	5859843	5862178
5870683	5884103	5884190	5889770	5898775	5898925
5903832	5903839	5907823	5912570	5914690	5914796
5917868	5920826	5926147	5926769	5929813	5930233
5946651	5953665	5956332	5956625	5956633	5960354
5960389	5963901	5966378	5977887	5983081	5987137
5987639	5991857	6005857	6006114	6009328	6011853
6011971	6014113	6014551	6014573	6025802	6026161
6028567	6031827	6035189	6035194	6038238	6043760
6047196	6049796	6050415	6054954	6054966	6055439
6060193	6069923	6072787	6073001	6079993	6081732
6084471	6084855	6084920	6084962	6088746	6094587
6097964	6105784	6112099	6115617	6118775	6119002
6119180	6121846	6122498	6128322	6128509	6130650
6133884	6137789	6138091	6140966	6144243	6144676
6148209	6151485	6151507	6163609	6164547	6167038
6167248	6167273	6170073	6171127	6178535	6182101

6184592	6185295	6185302	6185422	6188909	6195338
6199035	6201712	6201876	6202109	6219560	6223037
6223059	6230020	6240076	6249584	6259312	6262735
6266321	6266330	6269126	6271794	6272361	6282436
6285888	6292668	6295286	6307512	6308084	6311054
6314166	6317083	6324389	6324412	6333716	6347218
6356759	6359865	6359904	6363259	6370362	6370389
6377803	6377820	6381468	6385254	6385451	6392605
6392660	6400958	6417817	6430163	6434133	6437711
6438370	6445932	6453179	6456237	6456826	6463278
6470470	6487397	6510148	6522670	6591116	6606508
D423449	D481674	D485246			

Design patents pending:

29/166,907	29/177,162	29/177,164	29/177,165	29/177,171
------------	------------	------------	------------	------------

Contents

Quick guide	2
1. For your safety	3
About your device	4
Network Services	4
Shared memory	5
2. Welcome	6
Register your phone	6
E-newsletters	6
Copyright protection	6
Contact Nokia	6
3. SIM card and battery	8
SIM card installation	8
Install the battery	9
Charge the battery	10
Remove the SIM card	11
Set up your headset	11
4. About your phone	12
Switch on your phone	12
The antenna	13
The start screen	13
Indicators and icons	14
5. Make and answer calls	17
Make a call	17
End a call	17
Answer a call	18
Reject a call	18
Redial	18
6. The menu	19
Scroll bar	19
List of main menus and submenus	19
7. Text entry	26

Standard mode	26
Predictive text	27
Punctuation and special characters	28
8. Contacts	30
Save names, numbers, and e-mail addresses	30
Add text entries	31
Find names in Contacts	31
Edit names and numbers	32
Phone memory	32
Delete names and numbers	33
9. Call history	35
Check missed, received, or dialed calls	35
Call lists options	35
Clear call lists	36
Call timers	36
Message counter	37
Manage call costs	37
Data calls	38
10. Advanced calling features	39
In-call options	39
Automatic redial	40
1-touch dialing	40
Anykey answer	41
Network services	41
11. Voice features	45
Voice mail	45
Voice dialing	46
Voice commands	47
Audible alerts	48
12. Personalize your phone	49
Profiles	49
Accessory settings	50
Polyphonic sound (MIDI)	53
Ringing tones	53
Display language	54

Welcome note	54
Help text	54
Time and date	54
Memory status	56
Gallery	56
Display settings	58
Caller groups	59
Restore factory settings	60
Xpress-on™ color covers	60
13. Phone security	64
Lock the keypad (keyguard)	64
Security codes	64
PIN codes	65
PUK codes	66
Security code	67
Fixed dialing	67
Restrict calls	68
Closed user groups	69
14. Mobile messages	70
Message settings	70
Text messages	72
E-mail messages	74
Store messages	75
Delete messages	76
Picture messages	77
Multimedia messages	78
Info message service	81
Service command editor	81
15. Mobile Internet	82
Notes about the mobile Internet	82
Set up for browsing	83
Connect	83
Browser options	83
Navigate	83
Bookmarks	85
Security issues	85
GPRS	86

Disconnect	88
16. Instant messaging (IM)	89
IM service provider icons	89
Register with an IM service	90
IM menus	90
Log in	91
Set your availability	91
IM conversations	91
IM contacts	93
Group chat sessions	95
IM settings	96
Log off service	97
17. Your personal digital assistant	98
Calendar	98
Alarm clock	100
Business cards	101
Calculator	101
To-do list	102
Stopwatch	103
Synchronize contacts and calendar	105
18. Fun and games	107
Games	107
Java™ applications	109
Converter	111
19. Enhancements	112
Power	112
Audio	112
Car	112
20. Reference information	113
Battery information	113
Enhancements	113
Enhancements, batteries, and chargers	114
Care and maintenance	114
Additional safety information	115
Batteries	120

21. Technical information.....	121
22. Troubleshooting	122
23. Nokia One-Year Limited Warranty	123
Appendix A	127
Appendix B	131
Index.....	137

NOTES

Nokia 3595 phone at a glance

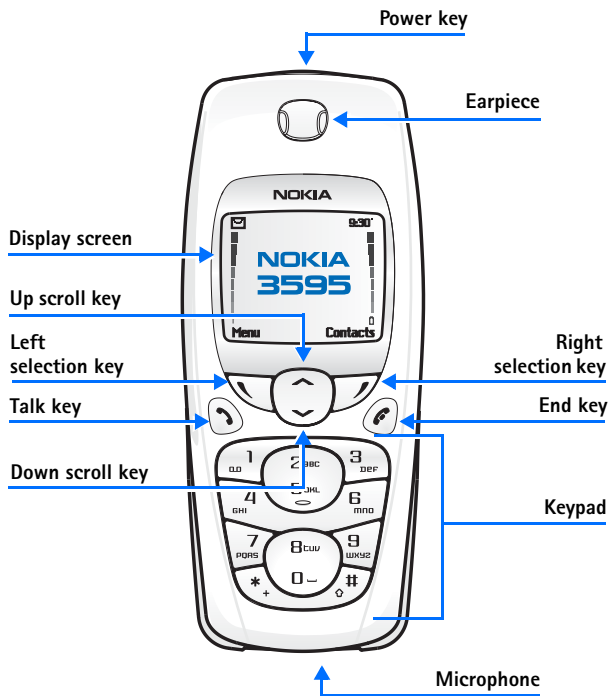

Quick guide

Action	Description
Press	Press a key briefly and release it.
Press and hold	Press a key, hold it for two to three seconds, and release it.
Make a call	Enter a phone number and press the Talk key.
Answer a call	Press the Talk key.
Answer call during call	Select Answer call .
End a call	Press the End key.
Decline a call	Press the End key to send the call to voice mail.
Mute a call	Select Options > Mute during a call.
Redial	Press the Talk key twice.
Adjust call volume	Press the Up scroll or Down scroll key during a call.
Use the in-call menu	Select Options during a call.
Save a name and number	Enter a number, select Options > Save , enter a name; then select OK .
Use 1-touch dialing	Press and hold a key (2–8). You must assign a key to a number in Contacts .
Look up a name	Select Contacts > Find .
Check voice mail	Press and hold the 1 key (contact your service provider for details).
Write text messages	Select Menu > Messages > Text messages > Create message . Enter the message.
Send text messages	Select Options > Send . Enter the number and select OK .
Read new message	If 1 message received appears on the display, select Show .



1 For your safety

Read these simple guidelines. Not following them may be dangerous or illegal. Read the complete user guide for further information.



SWITCH ON SAFELY

Do not switch the phone on when wireless phone use is prohibited or when it may cause interference or danger.



ROAD SAFETY COMES FIRST

Obey all local laws. Always keep your hands free to operate the vehicle while driving. Your first consideration while driving should be road safety.



INTERFERENCE

All wireless phones may be susceptible to interference, which could affect performance.



SWITCH OFF IN HOSPITALS

Follow any restrictions. Switch the phone off near medical equipment.



SWITCH OFF IN AIRCRAFT

Follow any restrictions. Wireless devices can cause interference in aircraft.



SWITCH OFF WHEN REFUELING

Don't use the phone at a refueling point. Don't use near fuel or chemicals.



SWITCH OFF NEAR BLASTING

Follow any restrictions. Don't use the phone where blasting is in progress.



USE SENSIBLY

Use only in the normal position as explained in the product documentation. Don't touch the antenna unnecessarily.



QUALIFIED SERVICE

Only qualified personnel may install or repair this product.



ENHANCEMENTS AND BATTERIES

Use only approved enhancements and batteries. Do not connect incompatible products.



WATER-RESISTANCE

Your phone is not water-resistant. Keep it dry.



BACKUP COPIES

Remember to make back-up copies or keep a written record of all important information stored in your phone.



CONNECTING TO OTHER DEVICES

When connecting to any other device, read its user guide for detailed safety instructions. Do not connect incompatible products.



EMERGENCY CALLS

Ensure the phone is switched on and in service. Press **End** as many times as needed to clear the display and return to the main screen. Enter the emergency number, then press **Talk**. Give your location. Do not end the call until given permission to do so.

• ABOUT YOUR DEVICE

The wireless device described in this guide is approved for use on the GSM 850 and 1900 networks. Contact your service provider for more information about networks. When using the features in this device, obey all laws and respect privacy and legitimate rights of others.



Warning: To use any features in this device, other than the alarm clock, the phone must be switched on. Do not switch the device on when wireless phone use may cause interference or danger.

• NETWORK SERVICES

To use the phone you must have service from a wireless service provider. Many of the features in this device depend on features in the wireless network to function. These Network Services may not be available on all networks or you may have to make specific arrangements with your service provider before you can utilize Network Services. Your service provider may need to give you additional instructions for their use and explain what charges will apply. Some networks may have limitations that affect how you can use Network Services. For instance, some networks may not support all language-dependent characters and services.

Your service provider may have requested that certain features be disabled or not activated in your device. If so, they will not appear on your device menu. Contact your service provider for more information.

- **SHARED MEMORY**

The following features in this device may share memory: ringing tones, pictures, screen savers, and Java™ games and applications. Use of one or more of these features may reduce the memory available for the remaining features sharing memory. For example, saving many games may use all of the available memory. Your phone may display a message that the memory is full when you try to use a shared memory feature. In this case, delete some of the information or entries stored in the shared memory features before continuing. Some of the features, such as ringing tones, pictures, screen savers, and Java games and applications may have a certain amount of memory specially allotted to them in addition to the amount of memory shared with other features.

2 Welcome

Congratulations on your purchase of the Nokia 3595 mobile phone. Your phone provides many functions which are practical for daily use, such as a stopwatch, alarm clock, to-do list, calendar, and more.

Look for updates

From time to time, Nokia updates this guide to reflect changes. The latest version may be available at www.nokiausa.com.

Also, an interactive tutorial may be available at www.nokiahowto.com.

Accessibility solutions

Nokia is committed to making mobile phones easy to use for all individuals, including those with disabilities. For more information, visit the web site at www.nokiaaccessibility.com.

• REGISTER YOUR PHONE

Make sure to register your phone at www.warranty.nokiausa.com or 1-888-NOKIA-2U (1-888-665-4228) so that we can serve your needs better if you should need to call the center or have your phone repaired.

• E-NEWSLETTERS

When you register your phone, you can sign up for Nokia's e-newsletter, *Nokia Connections*, if you would like. You will receive tips and tricks on using your phone, accessory information, and special offers.

• COPYRIGHT PROTECTION

Copyright protections may prevent some images, ringing tones, and other content from being copied, modified, transferred, or forwarded.

• CONTACT NOKIA

If you ever need to call Nokia Customer Care or your service provider, you will need to provide specific information about your phone.

Find information about your phone

This information is provided on the phone label. The label is on the back of the phone (under the battery). It contains the model and serial numbers, as well as other important information about your phone. See "Remove the back cover and battery" on page 8 for instructions on how to access the phone label. The label shows the following:

- Phone type
- Phone model
- IMEI
- FCC ID number

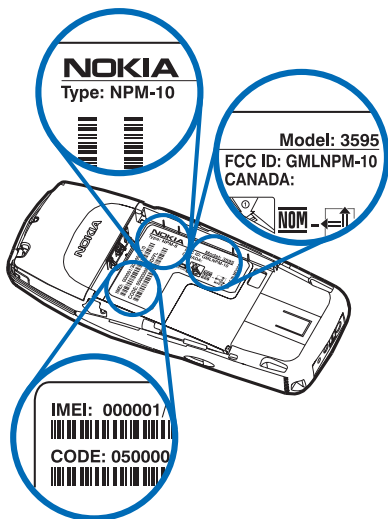

Have the phone or enhancement available

Whether you are calling about your phone or an enhancement, have the equipment with you when you call. If a Nokia representative asks a specific question about the enhancement, you will have it available for quick reference.

Nokia Customer Care Center, USA	Customer Care Centre, Canada
Nokia Mobile Phones 7725 Woodland Center Boulevard, Suite #150 Tampa, Florida 33614 Tel: 1-888-NOKIA-2U (1-888-665-4228) Fax: 1-813-249-9619 For TTY users: 1-800-24-NOKIA (1-800-246-6542)	Nokia Products Ltd. 601 Westney Rd. South Ajax, Ontario L1S 4N7 Tel: 1-905-427-1373 1-888-22-NOKIA (1-888-226-6542) Fax: 1-905-427-1070 Web site: www.nokia.ca

3 SIM card and battery

Before you begin, you need to prepare your phone by installing the SIM card and charging the battery. This chapter covers these topics, as well as instructions on how to attach the optional headset. Always switch off the phone before installing the SIM card and battery.

• SIM CARD INSTALLATION



Warning: Keep all SIM cards out of the reach of small children. For availability and information on using SIM card services, contact your SIM card vendor. This may be the service provider, network operator, or other vendor.

Remove the back cover and battery

- 1 With the back of the phone facing you, press and hold the back cover release button.
- 2 Slide the cover up; then lift it off the phone.
- 3 Lift out the battery.

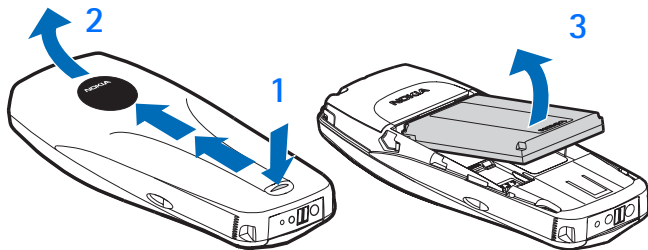

Install the SIM card

The SIM card and its contacts can easily be damaged by scratches or bending, so be careful when handling, inserting, or removing the card.

- 1 With the phone positioned as shown in the illustration below, locate the SIM card slot.
- 2 Install the SIM card by sliding it gently into the slot as shown in the illustration below, making sure the gold colored contact area is face down.

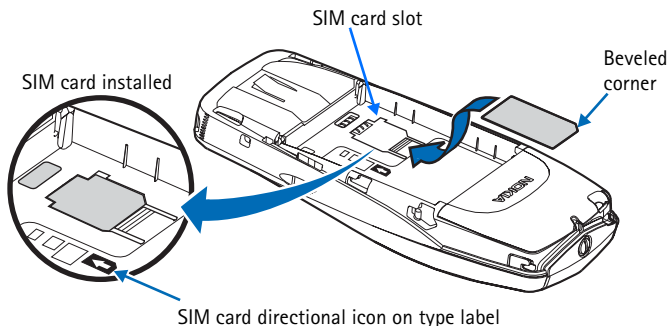

• INSTALL THE BATTERY

- 1 Position the battery (with the label side facing up), so the gold colored contacts match up with those on the phone.
- 2 Slide the battery until it snaps into place.

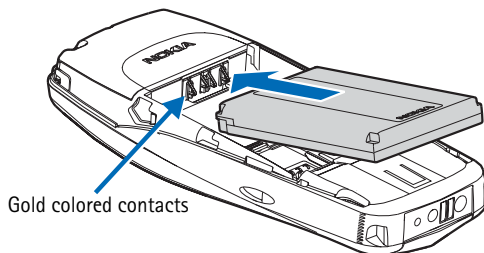

Replace the back cover

- 1 Direct the back cover towards the locking catches on the phone.
- 2 Slide the back cover until it locks into place.



Note: Always store and use the phone with the covers attached.

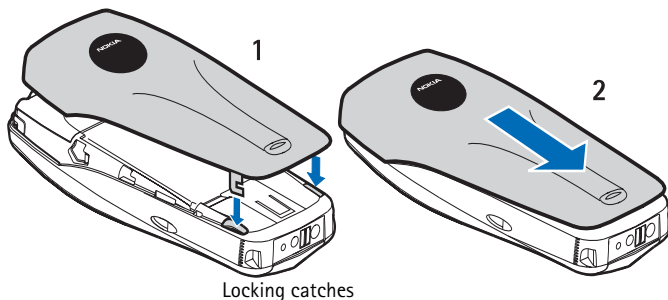

• CHARGE THE BATTERY

You can use the phone while the charger is connected.

- 1 Connect the charger to a standard wall outlet.
- 2 Insert the charger plug into the round jack in the bottom of the phone.

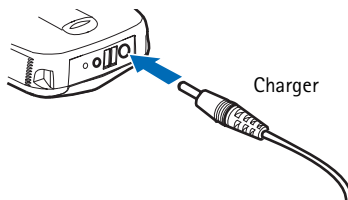

The battery power indicator (or battery bar) appears on the screen and starts scrolling. If the phone is on, **Charging** appears briefly on the screen. When the battery bar stops scrolling, the battery charge is complete. **Battery full** appears also, if the phone is on.

- 3 Disconnect the charger from the phone.



• REMOVE THE SIM CARD

If you ever need to remove the SIM card, follow these steps.

- 1 Remove the back cover and battery. See "Remove the back cover and battery" on page 8.
- 2 Press the plastic tab of the SIM card holder down.
- 3 Gently push the SIM card towards the top of the phone and remove it.

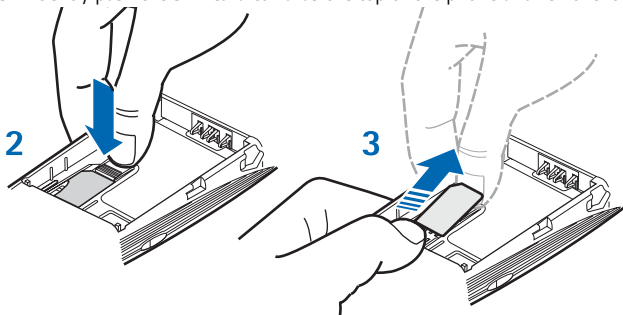

• SET UP YOUR HEADSET

Your phone may come with a headset (HDC-5) you can use while talking on your phone. The headset provides convenient hands-free use of the phone.

Connect the headset

- 1 Insert the headset plug into the headset jack in the phone.
- 2 Put the round ear bud into one ear.

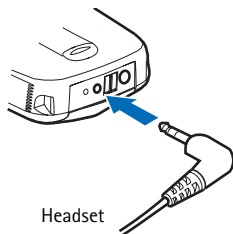

Headset

Use the headset



With the headset connected, you can make and answer calls as usual, using the keypad to press the **Talk** key and the **End** key or to enter numbers to call.

The microphone for the headset hangs at the side of your head. Although the microphone may seem far from your mouth, you can speak at a normal volume. Refer to the packaging materials of your headset for further information regarding its operation.

4 About your phone

• SWITCH ON YOUR PHONE



Warning: Do not switch the phone on when wireless phone use is prohibited or when it may cause interference or danger.

- 1 To turn your phone on or off, press and hold the **Power** key on top of the phone for at least three seconds.

If the phone displays **Insert SIM card**, even though the SIM card is properly inserted, or **SIM card not supported**, contact your service provider.

- 2 If the phone asks for a personal identity number (PIN) code, enter the PIN code (displayed as *****) and select **OK**.
- 3 See the information about PIN codes on page 65, if applicable.
- 4 If the phone asks for a security code, enter the security code and select **OK**.

See "Change the security code" on page 67 for more information.

If the language that appears in your display is not correct, see "Display language" on page 54 for information on changing the display language.

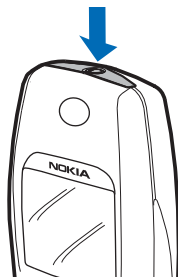

Back cover

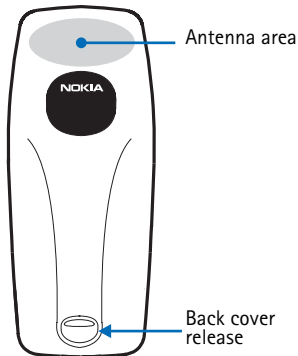

On the back of your phone, you will find the back cover release button. When you remove the back cover, you will find an antenna area, which is similar to the one shown in the graphic on the left.

• THE ANTENNA

Your phone has an internal antenna.



Note: As with any other radio transmitting device, do not touch the antenna unnecessarily when the device is switched on. Contact with the antenna affects call quality and may cause the phone to operate at a higher power level than otherwise needed. Avoiding contact with the antenna area when operating the phone optimizes the antenna performance and the battery life.



Not touching the antenna during a call optimizes the antenna performance and the talk time of your phone. Hold the phone as you would any other telephone, with the antenna area pointed up and over your shoulder.

• THE START SCREEN

When you turn on your phone, the first screen that appears is the start screen, which is in the standby mode. In the middle of the start screen, you may see information indicating which wireless network your phone uses. This information can vary between phones.

The **Left selection** key in the standby mode accesses **Menu** (the menu functions) and the **Right selection** key in the standby mode accesses the **Contacts** menu. Other indicators and icons appear on the start screen and are described in the next section.

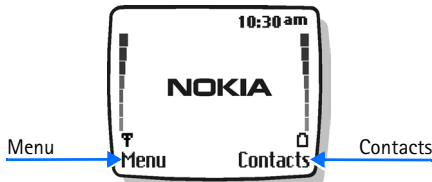

• INDICATORS AND ICONS

On your phone, you have two types of identifiers: indicators and icons.

Indicators

Indicators show the status of the phone.

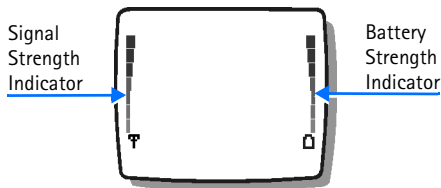



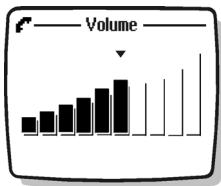











- The signal strength indicator shows the strength of the signal to your phone.
- The battery strength indicator shows how much power is left in your phone battery.
- The volume indicator shows the earpiece volume level. See "Adjust the earpiece volume during a call" on page 17 for details.
- The audible signal and battery indicator shows by a series of beeps that either the signal or battery strength is running low on your phone. You need to set up this feature on your phone through the voice command function before it will operate. See "Voice commands" on page 47 for more information.













Icons

Icons are graphical representations of a specific item or situation. The following table shows examples and tells you what each icon means.

Icon	What it means
1	Line 1 is selected for outgoing calls.
2	Line 2 is selected for outgoing calls.

Icon	What it means
	You have an active call.
	You have a call on hold.
	You have one or more new voice mail messages.
	You have a new voice mail message on line 1.
	You have new voice mail messages on line 1 and line 2.
	You have a new voice mail message on line 2.
	You have one or more new text messages. If the icon blinks, text message memory is full.
	Keyguard is on. Your phone will not accept any key presses.
	The alarm clock is set.
	The call alert and text message alert tones are turned off.
	The timed option for a profile is selected.
	Incoming voice calls are being forwarded to another number.
	You have forwarded all voice calls received on line 1.
	You have forwarded all voice calls received on line 2.
	You have forwarded all voice calls received on lines 1 and 2.

Icon	What it means
	The phone is ready for you to enter a response.
	There is a voice tag attached to a name in Contacts .
	Indicates an e-mail address in Contacts .
	You have assigned the name and number to a caller group.
	The headset is attached to your phone.
	The car kit is attached to your phone.
	The loopset is attached to your phone.
	A Telecommunications Device for the Deaf (TTY/TDD) is attached to your phone.
	The Contacts entry is stored on the SIM card.
	You are using predictive text input. Your phone uses a built-in dictionary to predict or guess the word entered.

5 Make and answer calls

This chapter tells you how to make and receive calls and how to adjust certain options.

• MAKE A CALL

Check the signal strength

The signal indicator on the left side of your phone screen shows the strength of the network radio signal. The indicator scrolls as the signal strength increases and decreases. To get the strongest signal, try moving your phone slightly. If you are inside a building, move toward a window.

Signal
Strength



Use the keypad

Enter the area code (if required in your local calling area) and phone number and press the **Talk** key.

Use Contacts

- 1 From the start screen, press the **Up scroll** key or the **Down scroll** key to scroll to the number you want.
- 2 Press the **Talk** key.

Adjust the earpiece volume during a call

You can only adjust the earpiece volume during an active call.

- To increase the volume of a call, press the **Up scroll** key.
- To decrease the volume of a call, press the **Down scroll** key.

When adjusting the volume, a bar chart appears in the display indicating the volume level.

If an enhancement with its own loudspeaker is connected to your phone, the volume keys adjust the volume for that enhancement.

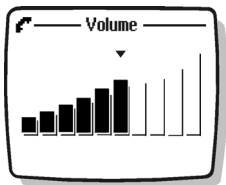

• END A CALL

Press the **End** key.

• ANSWER A CALL

Press the **Talk** key.

OR

Select **Options** > **Answer call**.

Caller ID



Note: This feature may not be available in all wireless systems. Contact your service provider for details and availability.

When caller ID is active, your phone may display the caller's phone number. The caller's name may also appear, if his or her name and number are stored in **Contacts**. See "Contacts" on page 30.

• REJECT A CALL

Press the **End** key.

OR

Select **Silence** > **Decline**.

OR

Select **Options** > **Decline call**.

• REDIAL

Last-dialed number

Press the **Talk** key twice.

Any of twenty last-dialed numbers

- 1 Press the **Talk** key and select the number you want to redial.
- 2 Press the **Talk** key again.

6 The menu

Your phone offers many functions that are grouped in menus and submenus. Access these menus with the selection keys and scroll keys. See “Nokia 3595 phone at a glance” on page 1 for the location of the selection keys and scroll keys.

• SCROLL BAR

While using phone menus, a scroll bar appears at the far right of the screen. This bar indicates where you are in the menu. Each numbered tab on the bar represents a different menu item.



For example, select **Menu** once. The scroll bar appears with the first (top) tab displayed. A different tab appears each time you press the **Up scroll** or **Down scroll** key.

• LIST OF MAIN MENUS AND SUBMENUS

Here is an abbreviated list of the main menus and their submenus. Later chapters tell you how to work with the menus, explaining their functions. Some items may not appear due to the SIM card configuration and network service availability.

1 Messages



- 1 Text messages
 - 1 Create message
 - 2 Inbox
 - 3 Create SMS e-mail
 - 4 Sent items
 - 5 Archive
 - 6 Templates
 - 7 My folders
 - 8 Distribution lists
 - 9 Delete messages
- 2 Multimedia messages
 - 1 Create message
 - 2 Inbox
 - 3 Outbox
 - 4 Sent items
 - 5 Saved items
 - 6 Delete messages

- 3 Voice messages
 - 1 Listen to voice messages
 - 2 Voice mailbox number
- 4 Info messages
 - 1 Info service
 - 2 Topics
 - 3 Language
 - 4 Info topics saved on SIM card
- 5 Message settings
 - 1 Text messages
 - 2 Multimedia msg.
 - 3 Other settings
- 6 Service command editor

2 Call log



- 1 Missed calls
- 2 Received calls
- 3 Dialed numbers
- 4 Delete recent call lists
 - 1 All
 - 2 Missed
 - 3 Received
 - 4 Dialed
- 5 Call timers
 - 1 Duration of last call
 - 2 Duration of received calls
 - 3 Duration of dialed calls
 - 4 Duration of all calls
 - 5 Life timer
 - 6 Clear timers
- 6 Call costs (*Depends on network availability and your SIM card*)
 - 1 Last call units
 - 2 All calls units
 - 3 Call cost settings
- 7 GPRS data counter
 - 1 Data sent in last session
 - 2 Data received in last session
 - 3 All sent data
 - 4 All received data
 - 5 Clear counters

- 8 GPRS connection timer
 - 1 Duration of last session
 - 2 Duration of all sessions
 - 3 Clear timers
- 9 Message counter
 - 1 Sent messages
 - 2 Received messages
 - 3 Clear counters

3 Profiles



- 1 Normal
 - 1 Select
 - 2 Customize
 - 1 Ringing options
 - 2 Ringing tone
 - 3 Ringing volume
 - 4 Vibrating alert
 - 5 Message alert tone
 - 6 Keypad tones
 - 7 Warning tones
 - 8 Alert for
 - 9 Profile name (*Appears under Silent, Meeting, Outdoor, My profile 1 and My profile 2*)
- 3 Timed
- 2 Silent
- 3 Meeting
- 4 Outdoor
- 5 My profile 1
- 6 My profile 2

4 Settings



- 1 Tone settings
 - 1 Ringing options
 - 2 Ringing tone
 - 3 Ringing volume
 - 4 Vibrating alert
 - 5 Message alert tone
 - 6 Keypad tones
 - 7 Warning tones
 - 8 Alert for

- 2 Time and date settings
 - 1 Clock
 - 2 Date
 - 3 Auto-update of date & time
- 3 Call settings
 - 1 Automatic redial
 - 2 1-touch dialing
 - 3 Summary after call
 - 4 Anykey answer
- 4 Phone settings
 - 1 Language
 - 2 Automatic keyguard
 - 3 Cell info display
 - 4 Welcome note
 - 5 Help text activation
 - 6 Start-up tone
 - 7 Memory status
- 5 Display settings
 - 1 Wallpaper
 - 2 Color schemes
 - 3 Operator logo (*Depends upon network availability*)
 - 4 Screen saver timeout
 - 5 Display brightness
- 6 Network services
 - 1 Call forwarding
 - 2 Call waiting
 - 3 Send own caller ID when calling
 - 4 Line for outgoing calls
 - 5 System selection
 - 6 Confirm SIM service actions
- 7 Accessory settings (*Only shows up when phone is connected to an enhancement*)
 - 1 Headset
 - 2 Handsfree (*Only shows up when phone is connected to Car Kit*)
 - 3 Loopset
 - 4 TTY/TDD
- 8 Security settings
 - 1 PIN code request
 - 2 Call restrictions
 - 3 Fixed dialing
 - 4 Closed user group
 - 5 Security level
 - 6 Change access codes
- 9 Restore factory settings

5 Gallery



- 1 View folders
- 2 Add folder
- 3 Delete folder
- 4 Rename folder
- 5 Gallery downl.

6 Organizer



- 1 Alarm clock
- 2 Calendar
- 3 To-do list

7 Games



- 1 Select game
 - 1 Air Glide
 - 2 Bowling
 - 3 Sky Diver
 - 4 Backgammon
- 2 Game downlds. *(depends on network availability)*
- 3 Memory
- 4 Settings
 - 1 Game sounds
 - 2 Game lights
 - 3 Shakes

8 Applications



- 1 Select app.
- 2 App. downloads
- 3 Memory

9 Extras



- 1 Calculator
- 2 Stopwatch
 - 1 Split timing
 - 2 Lap timing

- 3 Voice commands
 - 1 Audible alerts
 - 1 Audible battery bar
 - 2 Audible signal bar



- 10 Connectivity
 - 1 Synchronize
 - 2 GPRS connection



- 11 Services
THE FOLLOWING MENU ITEMS MAY VARY; CONTACT YOUR SERVICE PROVIDER.

- 1 Home
- 2 Bookmarks
- 3 Service inbox
- 4 Settings
 - 1 Connection settings
 - 1 Active service settings
 - 2 Edit active service settings
 - 2 Appearance settings
 - 1 Scroll mode
 - 2 Text wrapping
 - 3 Show images
 - 3 Security settings
 - 1 User certificates
 - 2 Authority certificates
 - 3 Security module settings
 - 4 Cookies
 - 4 Service inbox settings
 - 1 Service messages
 - 2 Automatic connection
- 5 Go to address
- 6 Clear the cache



12 IM

THE FOLLOWING MENU ITEMS MAY VARY. FOR AVAILABILITY AND INFORMATION ON USING INSTANT MESSAGING, CONTACT YOUR SERVICE PROVIDER.

- 1 Login
- 2 Saved convers.
- 3 IM provider
- 4 Settings

7 Text entry

You can use two methods for entering text and numbers.

- **Standard mode** is the only way to enter names into **Contacts**, enter a welcome note and to rename caller groups.
- **Predictive text input** is a quick and easy method for writing messages.

At any message screen, press the **#** key to switch predictive text on or off and to use predictive text in various modes. As you press the **#** key, the following icons (not the descriptions) appear in the upper left of the display:

Icon	What it means
	Uppercase text. Predictive text is Off .
	Lowercase text. Predictive text is Off .
	Sentence case text. Predictive text is Off .
	Sentence case text. Predictive text is On .
	Lowercase text. Predictive text is On .

See "Mobile messages" on page 70 for more information on how to access a message screen.



• STANDARD MODE

- Press a key once to insert the first letter on the key, twice for the second letter, etc. If you pause briefly, the last letter in the display is accepted and your phone awaits the next entry.
- Select **Clear** to backspace the cursor and delete a character.
- Select and hold **Clear** to backspace continuously and delete characters.
- Press the **0** key to enter a space and accept a completed word.
- Press the **1** key to enter a period.
- Press the ***** key to display special characters. See "Punctuation and special characters" on page 28.

To switch to **123** mode from **Abc** mode, press and hold the **#** key at any message entry screen until the icon in the upper left corner of the display switches from **Abc** to **123**.

• PREDICTIVE TEXT

Predictive text input allows you to write messages quickly using your keypad and the built-in phone dictionary. It is much faster than using the standard mode "multi-tap" method. You can use predictive text to write a message and create a calendar note.

When predictive text is on, the icon  appears in the upper left corner of the display. When predictive text is off, the icon  appears in the upper left corner of the display.

Activate

- 1 At a text entry screen, select and hold **Options**.
OR
At a text entry screen, select **Options > Predictive text**.
- 2 Select the language of your choice.

Enter text

- For each letter of the word that you want to spell, press the corresponding key on your keypad only *once*, even if the letter you want is not the first letter on the key. The phone *guesses* the word you are trying to spell.
- If a displayed word is not correct, press the * key to see other matches. To move forward through a list of matches, keep pressing the * key. To return to the previous word in the list of matches, select **Previous**.
- Press the **0** key to accept the word, enter a space, and begin writing the next word.
- If **?** appears after a word, select **Spell** to add the word to the dictionary. See "Add new words to the dictionary" on page 28.
- Press the **1** key to insert a period into your message.
- Press and hold the * key to display special characters. See "Punctuation and special characters" on page 28.

Compound words

- 1 Enter the first part of the compound word and confirm it by pressing the **Down scroll** key.
- 2 Enter the last part of the word and confirm it by pressing the **0** key.

Add new words to the dictionary

If you encounter a word that predictive text does not recognize, a question mark (?) follows the word and **Spell** appears in the lower left of the display.

Select **Spell**, enter your new word using the keypad, and select **Save**. The word is added to the dictionary and to the message that you are writing.

Keep these factors in mind when adding words:

- New words that you accept by selecting **Save**, the **0** key, or deleting the space between two words are saved to the dictionary.
- Depending on the language and the length of the words, you may be able to add hundreds of words to the dictionary.
- When the dictionary is full, the most recent addition replaces the first.

• PUNCTUATION AND SPECIAL CHARACTERS

In ABC mode

- 1 While at any text entry screen, press the ***** key to display the following special characters (press and hold the ***** key if predictive text is on):

. , ' ? ! " - ()
@ / : _ ; + € % *
= < > £ € \$ ¥ ¤ [
] { } \ ~ ^ ¡ ¢ §
| ⌂ ⬅

- 2 Scroll to the character you want and select **Insert**.

In 123 mode

You can access the following special characters only in 123 mode. There are two places you can use these characters:

- At the start screen, when you dial a phone number.
- At the number prompt, when you add a new entry to **Contacts**.

Press the * key	Function
Once to enter *.	Sends command strings to the network. Contact your service provider for details.
Twice to enter +.	Provides a prefix for dialing international numbers.
Three times to enter p.	Creates a pause that occurs when dialing a number. Numbers entered to the right of this special character are automatically sent as touch tones after a 2.5-second pause.
Four times to enter w.	Creates a wait; digits to the right of the w are not sent until you press the Talk key.

8 Contacts

You can keep track of contact information in **Contacts**.

- Names are saved in **Contacts** memory and/or SIM memory.
- For each name in the phone memory, you can add up to five phone numbers, including the following categories:



General phone number



Mobile phone number



Home phone number



Work phone number



Fax number

- For each name in the phone memory, you can also store an e-mail address, a web address, a street address, and a note. See "E-mail address" on page 31 and "Add text entries" on page 31.
- For more details about phone memory and SIM memory, see "Phone memory" on page 32.

• SAVE NAMES, NUMBERS, AND E-MAIL ADDRESSES

Quick save

- 1 At the start screen, enter the number you want to save and select **Options**.
- 2 Select **Save**, enter the name, and select **OK**.

Number only

At the start screen, enter the number, and select and hold **Options**.

Name and number while in a call

- 1 At the start screen, select **Options > Contacts > Add contact**.
- 2 Enter the name, select **OK**, enter the phone number, and select **OK**.

E-mail address

You can save an e-mail address for a name in **Contacts**. All **Contacts** entries that contain e-mail addresses must be stored in the phone memory. See "Phone and SIM memory" on page 32.

- 1 At the start screen, press the **Up scroll** or the **Down scroll** key to scroll to the name you want.
- 2 Select **Details > Options > Add detail**.
- 3 If the name has been saved to the SIM card, the phone prompts you to move it to the phone memory; then select **OK**.
- 4 Select **E-mail**, enter the e-mail address, and select **OK**.

• ADD TEXT ENTRIES

Besides adding an email address for each name in **Contacts**, you can also add a web address, street address, or note for each name.

- 1 At the start screen, press the **Up scroll** or the **Down scroll** key to scroll to the name you want.
- 2 Select **Details > Options > Add detail**.
- 3 If the name has been saved to the SIM card, the phone prompts you to move it to the phone memory; then select **OK**.
- 4 Select either **Web address**, **Street addr.** or **Note**, enter your information, and select **OK**.

• FIND NAMES IN CONTACTS

- 1 Select **Contacts > Find** and the name you want.
- 2 Select **Details** to show the phone number.
- 3 To call the number, press the **Talk** key.

Use scroll keys

At the start screen, press the **Up scroll** or the **Down scroll** key to scroll to the name you want.

• EDIT NAMES AND NUMBERS

Names

- 1 At the start screen, press the **Up scroll** or **Down scroll** key to scroll to the name you want to change.
- 2 Select **Details > Options > Edit name**.
- 3 Select **Clear** as many times as necessary to delete the name, enter the new name, and select **OK**.

Numbers

- 1 At the start screen, press the **Up scroll** or **Down scroll** key to scroll to the number you want to change.
- 2 Select **Details > Options > Edit number**.
- 3 Select **Clear** as many times as necessary to delete the number, enter the new number, and select **OK**.

• PHONE MEMORY

You can save names and numbers in the internal memory of the phone, SIM card memory, or in a combination of the two. The SIM icon  appears when a **Contacts** entry is saved in SIM memory.

The shorter the names and numbers, the more entries you can store in **Contacts**. The phone memory can hold from 125 to 500 names, depending on the number of characters used for each name, number, or text entry.

Phone and SIM memory

The following table summarizes the differences between the three types of memory you can choose.

Phone feature	Phone memory	SIM memory	Phone and SIM memory
Contact names capacity	Up to 500 (depending on length of entries)	Up to 250 contact names (Depends on your SIM card; check with your service provider)	Up to 750 contact names (both SIM and phone entries are displayed)
Phone numbers	Up to 5 numbers per name	1 number (Depends on your SIM card; check with your service provider)	Up to 5 numbers per name (stored in phone memory)

Phone feature	Phone memory	SIM memory	Phone and SIM memory
E-mail, Web address, Street address and Note	Up to 3 text entries per name	Not available	Up to 3 text entries per name (stored in phone memory)
Caller groups?	Yes	Yes	Yes
Transfer contact names/numbers to another phone?	No	Yes, contact your service provider for details.	Only numbers stored to SIM can be transferred
Voice tags?	Yes	Yes	Yes

Switch between memory types

The default memory type is **Phone and SIM**.

Select **Contacts > Settings > Memory in use > Phone and SIM, Phone, or SIM card**.

If you choose to keep **Phone and SIM** as the memory type:

- **Contacts** names and numbers can be recalled from both the phone and SIM card
- **Contacts** entries are displayed in a combined list
- New entries are saved to the phone memory.

Check Contacts memory status

Select **Contacts > Settings > Memory status > Phone or SIM card**.

If your list in **Contacts** is full, you can save the phone number to another memory or replace an existing entry.

• DELETE NAMES AND NUMBERS

Number

- 1 At the start screen, press the **Up scroll** or the **Down scroll** key to scroll to the entry you want to delete.
- 2 Select **Details > Options > Delete number > OK**.

Name and number

- 1 At the start screen, press the **Up scroll** key or the **Down scroll** key to scroll through **Contacts** until you find the entry you want to delete.
- 2 Select **Details > Options > Delete > OK**.

Entire Contacts contents



Warning: This feature deletes the entire contents of **Contacts** and cannot be undone. Some repair services for your phone may erase your contact list entries. Be sure to make a copy of all information before requesting any repair service.

- 1 Select **Contacts > Delete > Delete all > Phone or SIM card > Delete > OK**.
- 2 Enter your security code and select **OK**. See "Security code" on page 67 for the default code.

9 Call history

Your phone registers information about each call you make and receive. The **Call log** keeps track of the following:

- Missed calls
 - Received calls
 - Dialed calls
 - General packet radio system (GPRS) data sent and received.
 - Time spent online for GPRS data transfers
 - Text messages sent and received
- **CHECK MISSED, RECEIVED, OR DIALED CALLS**

Your phone saves the last 20 numbers you have dialed or the last 10 numbers you have missed or received. The **Call log** saves the phone numbers of missed or received calls only if the caller's number is available, your phone is turned on, and you are in your home calling area.

 - 1 Select **Menu > Call log > Missed calls, Received calls, or Dialed numbers** and select the number you want to see.
 - 2 To dial the number, press the **Talk** key.
 - 3 Select **Options** to find more information or to add a number to **Contacts**.

- **CALL LISTS OPTIONS**

When you view the missed calls, received calls, or dialed calls list and select **Options**, the following choices may appear. Not all options will appear each time and the order of options may vary.

Call time—Shows the date and time of the last call. Use the scroll keys to view up to five recent call dates/time for the displayed phone number.

Send message—Allows you to write a short text message to the person who called you.

View number—Displays the phone number if the caller's name is stored in **Contacts**.

Edit number—Allows you to edit the displayed number and save it with a name to **Contacts**.

Save—Allows you to enter a name for the number and save both to **Contacts**.

Add to contact—Allows you to move a contact to phone memory.

Delete—Allows you to delete the number from the call list.

Call—Dials the number from the **Call log**.

• CLEAR CALL LISTS

This feature clears all the missed, received, and dialed call lists.



Warning: You cannot undo this operation.

Select **Menu** > **Call log** > **Delete recent call lists** > **All, Missed, Received, or Dialed**.

Missed, received, and dialed calls lists are also deleted when you change the phone security setting or if you use a SIM card that is not one of the five most recent cards used with the phone.

• CALL TIMERS



Note: Some timers, including the life timer, may be reset during service or software upgrades. The actual time invoiced for calls by your service provider may vary, depending on network features, rounding off for billing, and so forth.

Two phone lines

If you subscribe to a second phone line (see "Two phone lines" on page 45), call timers are separate for each phone line. When you view call timers, the call timers that are shown are for the currently selected outgoing line. However, if you view call timers while you are in a call, the call timers that are shown are for the line you are using at that moment.

View call duration

- 1 Select **Menu** > **Call log** > **Call timers** > **Duration of last call, Duration of received calls, Duration of dialed calls, or Duration of all calls**.
- 2 Select **Back** after viewing the selected call timer.

View the life timer

Your phone keeps track of the total call time (all calls made and received). The life timer is displayed in **hhh:mm** format.

- 1 Select **Menu** > **Call log** > **Life timer**.
- 2 Select **Back** after viewing the life timer.

Reset call timers to zero



Note: You cannot reset the life timer. However, sometimes the life timer may be reset during service or software upgrades.

Select **Menu** > **Call log** > **Call timers** > **Clear timers**, enter your security code, and select **OK**.

Show call timer during a call

While in a call, select **Options > Menu > Call log > Call timers**.

Show call timer after call

Your phone can display the time spent on a call after you end the call. This feature is called **Summary after call**.

Select **Menu > Settings > Call settings > Summary after call > On or Off**.

• MESSAGE COUNTER

The message counter gives you information on how many text messages have been sent and received. You can view the amount of sent and received messages, view details about the messages and reset the counter.



Note: The actual amount invoiced by your service provider may vary.

- 1 Select **Menu > Call log > Message counter > Sent messages or Received messages**.
- 2 Select the message (phone number) you want to see.
- 3 To dial the number, press the **Talk** key.
- 4 Select **Options** and one of the following options:

Message details—Shows either the sender or recipient of the message, along with details of the sent message.

Send message—Allows you to write a short text message to the person who either sent you a message or received a message from you. This option will display if the message was sent to or received from a phone number.

Call—Allows you to call the person who either sent you a message or received a message from you.

Edit number—Allows you to edit the displayed number and save it with a name to **Contacts**.

Save—Allows you to enter a name for the number and save both to **Contacts**.

Add to contact—Allows you to move a contact to phone memory.

Delete—Allows you to delete the number from the message list.

• MANAGE CALL COSTS

This network service allows you to check call costs. You can view the last call cost or the total cost of all calls made or received since the counters were reset. Contact your service provider for availability and instructions.



Note: The actual invoice for calls and services from your service provider may vary, depending on network features, rounding off for billing, taxes and so forth.

• DATA CALLS

In addition to keeping track of voice calls, the phone call log records information about data calls. You can check the amount of GPRS data transferred over the network. You can also keep track of how much time you spend online.



Note: Text messages sent over GPRS are not counted and therefore not included in the data counter or connection timer. For details on pricing and availability, contact your service provider.

Data counter

CHECK

All data counters are displayed in bytes (B).

Select **Menu > Call log > GPRS data counter** and one of the following options:

Data sent in last session

Data received in last session

All sent data

All received data

CLEAR

Select **Menu > Call log > GPRS data counter > Clear counters**, enter your security code and select **OK**.

Connection timer

CHECK

The time is displayed in **hh:mm:ss** format.

Select **Menu > Call log > GPRS connection timer** and one of the following options:

Duration of last session

Duration of all sessions

CLEAR

Select **Menu > Call log > GPRS connection timer > Clear timers**, enter your security code, and select **OK**.

10 Advanced calling features

This chapter covers advanced calling features, including:

- In-call options and swapping between calls
- Call settings that you control such as anykey answer
- Network services such as call forwarding

Not all features that are described are available in all wireless networks. Contact your service provider for availability of network services.

• IN-CALL OPTIONS

During a call, select **Options** to see the in-call menu. Not all options will appear each time and the order of options may vary.

Lock keypad—Allows you to lock the phone keypad.

End call—Ends the current call.

New call—Allows you to place a new call.

Touch tones—Sends touch tones. Touch tones are the sounds generated when you press a key; touch tones can be used for automated, over-the-phone services such as checking airline arrival or departure times.

Contacts—Switches you to **Contacts**, so that you can look up a name, number, or address.

Menu—Allows you to access the phone menu.

Mute—Disables the microphone so that the other party cannot hear you speak. **Mute** also affects the microphone of any external enhancements connected to your phone.

Hold—Holds or releases a call.

New call



Enter the second phone number or recall it from **Contacts** and press the **Talk** key.
OR

- 1 Select **Options > New call**.
- 2 Enter the second phone number or recall it from **Contacts** and select **Call**.

With either method, the first call is automatically put on hold.

SWITCH BETWEEN TWO CALLS IN PROGRESS

Press the **Talk** key or select **Swap**.

The  icon represents the active call and the  icon represents the call on hold.

END THE ACTIVE CALL

Press the **End** key.

The call on hold becomes the active call.

International call

- 1 Press the ***** key twice to enter the international dialing prefix (+).
- 2 Enter the country code, area code, and phone number, then press the **Talk** key.

• AUTOMATIC REDIAL

Select **Menu > Settings > Call settings > Automatic redial > On**.

If the number you dial is busy, your phone immediately redials the number. If it is still busy, your phone will redial the number up to nine more times. Automatic redial will not work while you make or answer another call.

• 1-TOUCH DIALING

Assign a name and number to a 1-touch dialing location so that when you press this key, the phone automatically dials the associated number.

The **1** key is used to access your voice mail. See "Listen to your voice messages" on page 46 for details on voice mail.

Activate

Select **Menu > Settings > Call settings > 1-touch dialing > On**.

Assign number

- 1 Select **Contacts > 1-touch dialing**, a dialing location, and **Assign**.
- 2 Enter a phone number, select **OK**, enter a name, and select **OK**.
OR
Select **Find** and the **Contacts** entry you want.

Call

At the start screen, press and hold the appropriate key.

OR

At the start screen, press the appropriate key and the **Talk** key.

Change

- 1 Select **Contacts > 1-touch dialing**, the key you want to change, and **Options > Change**.
- 2 Enter a phone number, select **OK**, enter a name, and select **OK**.

Delete

- 1 Select **Contacts > 1-touch dialing**, then select the key you want to delete.
- 2 Select **Options > Delete > OK**.

• ANYKEY ANSWER

Anykey answer allows you to answer an incoming call by briefly pressing any key except the **Power** key, the **Left selection** key, the **Right selection** key, and the **End** key. Select **Menu > Settings > Call settings > Anykey answer > On** or **Off**.

• NETWORK SERVICES

Your phone supports a number of services that may be available through your service provider's network such as, call forwarding, call waiting, caller ID, multiple lines for outgoing calls, and system selection. For availability, pricing, and subscription to network services, contact your service provider.

Outgoing line

Your service provider must have this feature activated before you can select line 2. Select **Menu > Settings > Network services > Line for outgoing calls > Line 1** or **Line 2**.

Own number in caller ID

You can determine, for each call you make, whether your telephone number appears on another's phone caller ID. This feature is network-dependent and works on a call-by-call basis. Contact your service provider for more information.

- 1 Select **Menu > Settings > Call settings > Network services > Send own caller ID when calling**.
- 2 Select one of the following options:
 - Default**—Your phone number is sent according to the network.
 - Yes**—Your phone number is sent to the other person's caller ID.
 - No**—Your phone number is not sent to the other person's caller ID.

Call forwarding

Call forwarding tells your network to redirect incoming calls to another number. It is a network-dependent feature and may not work the same in all networks. Contact your service provider for availability.

ACTIVATE

- 1 Select **Menu > Settings > Network services > Call forwarding** and one of the following options:



Note: If you want to forward your calls to another number when your phone is turned off, select **Forward when not able to take calls**.

Forward all voice calls

Forward if busy

Forward if not answered

Forward if out of reach

Forward when not able to take calls

Forward all fax calls

Forward all data calls

Cancel all call forwarding

- 2 Select **Activate > To voice mailb.** or **To other no.** If you select **To other no.**, enter the phone number and select **OK**.

The following icons appear on the phone screen:



Incoming voice calls are being forwarded to another number.



You have forwarded all voice calls that are received on line 1.



You have forwarded all voice calls that are received on line 2.



You have forwarded all voice calls that are received on lines 1 and 2.

CANCEL

- 1 Select **Menu > Settings > Network services > Call forwarding**.
- 2 Select the call forwarding option you want and **Cancel**.



Note: Canceling all call forwarding may also cancel any automatic forwarding of calls to voice mail that your service provider has activated for you. Also, this option may cancel your call forwarding service. Contact your service provider for details.

CHECK CALL FORWARDING STATUS

The **Check status** option is not available for **Forward when not able to take calls**.

- 1 Select **Menu > Settings > Network services > Call forwarding**.
- 2 Select the call forwarding option you want and **Check status**.

To see the phone number where the calls are being forwarded, select **Number**.

Select a system

You can select how your phone chooses a wireless network, as there may be more than one available. The selection you make stays active until you change it or change the SIM card.

Select **Menu > Settings > Network services > System selection** and one of the following options:

Automatic—The phone automatically selects one of the available systems.

Manual—The phone searches for available systems and then lists them. Select the system you want. The phone looks for a system and displays the result. If you lose connection while in **Manual** mode, the phone asks you to select a system again.

Call waiting

This network service lets you receive an incoming call when you are already in a call. The phone beeps to let you know of the incoming call. Contact your service provider to sign up for call waiting.

Select **Menu > Settings > Network services > Call waiting > Activate** or **Cancel**.

CONFIRM STATUS

Select **Menu > Settings > Network services > Call waiting > Check status**.

ANSWER A WAITING CALL

Your phone signals when you have a call waiting.



Press the **Talk** key or select **Answer** to put the current call on hold and answer the waiting call.

REJECT A WAITING CALL

Select **Options > Decline call**.

SWITCH BETWEEN CALLS

Press the **Talk** key or select **Swap**.

The  icon represents the active call and the  icon represents the call on hold.

END THE ACTIVE CALL

Press the **End** key or select **Options > End call and** the call on hold becomes active.

THIRD CALL WAITING

If you have both an active call and a call on hold and a third call is waiting, you can answer the third call and end the other calls.

Select **Options > End all calls**, then press the **Talk** key to answer the third call.

Conference calls

This network service, if available from your service provider, allows you to make conference calls with your phone. Contact your service provider for availability.

MAKE

- 1 Place a call to the first person.
- 2 Select **Options > New call**, enter the number of the next party you want to include, and select **Call**.
- 3 After the other party answers, select **Options > Conference**.
- 4 To add other parties to the call, repeat steps 2–3.
- 5 To end the conference call, press the **End** key.

TALK PRIVATELY

- 1 While in a conference call, select **Options > Private call**.
- 2 Select the person with whom you want to speak privately.
The other participants can continue talking with each other.
- 3 To rejoin the conference call, select **Options > Conference**.

Transfer calls

This network service, if available from your service provider, allows you to connect an active call and a call on hold and disconnect yourself from the call. Contact your service provider for availability.

During a call, select **Options > Transfer calls**.

11 Voice features

The voice features in your phone make communication more convenient. You can check messages from friends or business associates, record a voice tag for contacts in the **Contacts** function, and use voice dialing for handsfree operation.

• VOICE MAIL

Voice mail is a network feature that allows callers to leave a voice message for you when you are not able to take the call. To use voice mail, you must have:

- A voice mail subscription
- A voice mailbox number
- A temporary password

These items are assigned by your service provider. Your service provider should also tell you how to record a greeting for your voice mailbox and how to change the temporary password. If you have difficulty using the voice mail feature, contact your service provider.

Voice mailbox number

If your service provider has not already set up the voice mailbox number, follow these steps to set up the voice mailbox number.

- 1 Select **Menu > Messages > Voice messages > Voice mailbox number**.
- 2 Enter your voice mailbox number and select **OK**.

The voice mailbox number must be longer than two characters and emergency numbers, such as 911, are not allowed.

Two phone lines

If your particular SIM card supports it, your phone can have two phone lines. Your service provider can tell you if your SIM card allows the use of this feature and can give you access to two phone lines.

If you decide to use two phone lines, you can select one of the two lines for outgoing calls, but you can still answer calls on both lines. If you use two phone lines, you will be given a voice mailbox number for each line. You need to save the voice mailbox number for each phone line separately.

To do this, first select the outgoing line and save its voice mailbox number. Then, select the other line and save its number.

Voice mail indicators

The method of voice mail notification depends upon your service provider. When you receive a voice message, your phone beeps and either an icon  or **n message received** appears, where **n** is the number of messages. To view the message immediately, select **Show**; to view the message later, select **Exit**.

If you subscribe to two different phone numbers, the message icon shows which line is receiving the voice mail message.



Voice mail message on line 1.



Voice mail message on line 2.



Voice mail message on line 1 and on line 2.

Listen to your voice messages

If there is a notification message on your screen, you can get your voice messages by using one of the following methods:

- If you have saved your voice mailbox number in your phone, press and hold **1** to call your voice mailbox.
- Call your voice mailbox number as you would any other telephone number; then follow the directions provided.

To check your voice messages anytime, **Menu > Messages > Voice messages > Listen to voice messages**.

• VOICE DIALING

The phone voice dialing feature allows handsfree operation while you place a call. Before using this feature, you need to create entries in **Contacts** so you can associate a voice tag with a name and number. You can create up to 14 voice tags in your phone. To create entries in **Contacts**, see page 30.

Voice tags

Before using voice tags, note that:

- Voice tags are not language-dependent. They are dependent on the speaker's voice.
- You must say the name exactly as you said it when you recorded it.
- Voice tags are sensitive to background noise. Record voice tags and use them in a quiet environment.
- Very short names are not accepted. Use long names and avoid similar names for different numbers.



Note: Using voice tags may be difficult in a noisy environment or during an emergency, so you should not rely solely upon voice dialing in all circumstances.

Add

- 1 At the start screen, press the **Up scroll** or the **Down scroll** key to scroll to the name you to which you want to assign a voice tag.
- 2 Select **Details > Options > Add voice tag**.
- 3 Select **Start**, then speak the name clearly into the microphone.



Important: Do *not* select **Quit** unless you want to cancel the recording. The phone automatically stops recording, then replays and saves the voice tag.

Make a call

- 1 Select and hold **Contacts**. When you hear several beeps and **Please speak now** appears, release the button.
- 2 Pronounce the voice tag clearly into the microphone and your phone automatically dials the number.

Listen

- 1 Select **Contacts > Voice tags** and the name with the voice tag you want to hear.
- 2 Select **Options > Playback**.

Change

- 1 Select **Contacts > Voice tags** and the name with the voice tag you want to change.
- 2 Select **Options > Change > Start** and speak the new name.

Delete

- 1 Select **Contacts > Voice tags** and the name with the voice tag you want to delete.
- 2 Select **Options > Delete > OK**.

• VOICE COMMANDS

The voice command feature allows access to handsfree operation for certain phone functions. Voice commands work similar to voice dialing. Before using voice commands, you must first associate a voice tag to the phone function you want to use.

Add a voice tag

- 1 Select **Menu > Extras > Voice commands > Audible alerts > Audible battery bar** or **Audible signal bar > Options > Add command**.
- 2 Select **Start** and speak the voice tag clearly into the microphone.



Note: A message will appear if the voice tag is either too short or long. You are given the option to try again. Do not select **Quit** unless you want to cancel the recording.

The phone replays and then saves the recorded tag. The  icon appears next to commands which have voice tags assigned.

Existing voice command

After you have associated a voice tag to a command, you can either play back, change or delete the tag.

PLAY BACK

- 1 Select **Menu > Extras > Voice commands > Audible alerts** and the voice command tag you want to play back.
- 2 Select **Options > Playback**.

CHANGE

- 1 Select **Menu > Extras > Voice commands > Audible alerts** and the voice command tag you want to change.
- 2 Select **Options > Change > Start**, then speak the voice tag clearly into the microphone.

DELETE

- 1 Select **Menu > Extras > Voice commands > Audible alerts** and the voice command tag you want to delete.
- 2 Select **Options > Delete > OK**.

• AUDIBLE ALERTS

Audible alerts provide you with audible tones to indicate the current signal bar or battery bar strength of your phone. In order to obtain audible alerts, the alerts must first be set up as voice commands. To set up voice commands, see "Add a voice tag" on page 47.

Select and hold **Contacts** and speak the voice tag clearly into the microphone.

When the phone finds the tag, confirmation appears and the phone plays the recognized voice tag from the phone memory through the earpiece. The phone then beeps to indicate how strong the battery or signal strength is. The following table shows what the number of beeps indicates.

Audible Alert	One Beep	Two Beeps	Three Beeps	Four Beeps
Battery Bar Strength	Low	Half full	Almost full	Full
Signal Bar Strength	Weak	Somewhat strong	Almost strong	Strong

12 Personalize your phone

• PROFILES

The **Profiles** option allows you select the sound settings that match your environment, whether it is a meeting or a soccer game. Each profile contains settings for the ringing option, ringing tone, ringing volume, vibrating alert, message alert tone, keypad tones, and warning tones. The profiles available are **Normal**, **Silent**, **Meeting**, **Outdoor**, **My profile 1**, and **My profile 2**.

Your phone also has profile settings for Nokia enhancements (accessories) such as a headset, car kit, loopset, and phone adapter.



Note: The profiles for enhancements do not appear until you attach these enhancements for the first time.

Select

Select **Menu > Profiles** and the profile you want to use.

Customize

- 1 Select **Menu > Profiles** and the profile you want to customize.
- 2 Select **Customize** and one of the following options:

Ringing options—Set the ringing style. The choices include **Silent**, **Ring**, **Ascending**, **Ring once**, and **Beep once**.

Ringing tone—Set the ringing tone from a selection of preprogrammed tones.

Ringing volume—Set the volume for incoming calls.

Vibrating alert—Set the vibrating alert on or off. Your phone has an internal vibrating mechanism so you do not need a special battery to use this feature. In some profiles, the vibrating alert default is **Off**, so the lights may not flash unless you change the default.

Message alert tone—Set the alert style. The choices include **No tone**, **Standard**, **Special**, **Beep once**, **Ascending**, and **Ringing Tone**.

Keypad tones—Set the volume for keypad tones.

Warning tones—Set the warning and confirmation tones on or off.

Alert for—Set an audible alert only when a member of a selected caller group is calling. The choices include **Family**, **VIP**, **Friends**, **Business** or **Other**. Scroll to the caller group for whom you want to set an alert and select **Mark > Done**. For more information about caller groups, see "Caller groups" on page 59.

Profile name—Assign a new name to any of the following profiles: **Silent**, **Meeting**, **Outdoor**, **My profile 1**, or **My profile 2**.

Set timed

Timed profiles can prevent missed calls. For example, if you attend an event that requires you to set your phone to the **Silent** profile, you may forget to return the phone to the **Normal** profile after the event is over. You may not notice incoming calls. With the timed profile, you can have the phone automatically return to the **Normal** profile at a time you specify.

- 1 Select **Menu > Profiles** and the profile you want to activate
- 2 Select **Timed**, enter the time for the profile to expire, and select **OK**.
- 3 If you are using a 12-hour time format, select **am** or **pm**.

• ACCESSORY SETTINGS

You can use your phone with these Nokia enhancements:

- Headset (HDC-5, HDE-2, HDB-5, or HDC-10)
- Car kit (CARK-125 or CARK-134)
- Loopset (LPS-3)
- Phone adapter (HDA-9)

The **Accessory settings** do not appear in the phone menu until you connect the headset, car kit, loopset, or phone adapter.

You can adjust settings related to the enhancement, such as a ringing tone.

Default profile

When you use the headset, car kit, or loopset, you have the option of choosing a profile. You can use the currently selected profile (for example, **Normal**) or you can choose from the list.

Select **Menu > Settings > Accessory settings > Headset, Handsfree, or Loopset > Default profile** and the profile you want.

Car profile

You can connect your phone to a compatible Nokia car kit for convenient handsfree operation. The car kit contains a microphone and a speaker, so you can conduct a conversation without holding the phone to your ear. The setting used with the car kit is called **Handsfree**. Connecting your phone to a car kit automatically disables the keyguard.

AUTOMATIC ANSWER

This profile lets your phone answer incoming calls after just one ring.

- 1 Place the phone into the car kit holder.
- 2 Select **Menu > Settings > Accessory settings > Handsfree > Automatic answer > On**.

LIGHTS

If you are using your phone with a compatible Nokia car kit, you can set lights to **On** (display and keypad lights stay on) or **Automatic** (after 15 seconds, lights turn off until the next key is pressed or the phone rings).

- 1 Place the phone into the car kit holder.
- 2 Select **Menu > Settings > Accessory settings > Handsfree > Lights > On or Automatic**.

Loopset profile

The LPS-3 loopset gives people with T-coil equipped hearing aids the ability to make and receive calls without noise interference.

 **Important:** Refer to the booklet that comes with the LPS-3 for complete instructions and safety information.

- 1 Plug the loopset plug into the jack in the bottom of the phone, as shown in the illustration.
- 2 Select **Menu > Settings > Accessory settings > Loopset**.
- 3 Select **Use loopset > Yes**.

 **Note:** If you want to use the headset or TTY/TDD, you perform steps 2–3, then select **No** to deactivate the loopset profile.

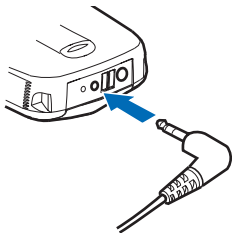

TTY/TDD profile

You can connect your phone to a TTY/TDD device, using the Nokia phone adapter (HDA-9). In order for your phone to recognize the TTY/TDD, you'll need to set up the TTY/TDD profile, under **Accessory settings**.



Important: Some manufacturers of TTY/TDD devices suggest that the phone be least at 18 inches from the TTY/TDD device. Remember that when connecting to any other device, read its user guide or contact its manufacturer for detailed instructions and safety information.

- 1 Connect the TTY/TDD device by a cable to the HDA-9 phone adapter.
- 2 Plug the HDA-9 phone adapter into the connector in the bottom of your phone, as shown in the illustration.

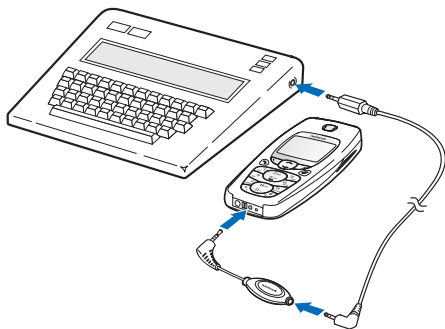

- 3 Select **Menu > Settings > Accessory settings > TTY/TDD > Use TTY > Yes**.

TTY/TDD Calls

NOTES

- The Nokia TTY/TDD phone adapter (HDA-9) is for use with compatible TTY/TDD devices only. Check with the manufacturer of the TTY/TDD device to ensure that the connection is compatible.
- Check with the manufacturer of the TTY/TDD device for the connecting cable.
- TTY/TDD communications depend on network availability. Check with your service provider for availability and description of services.

MAKE

Before making a TTY/TDD call with your Nokia phone, check the signal strength. See page 17 for more details.

- 1 At the start screen, enter the phone number and press the **Talk** key.
- 2 When the receiving party answers, begin typing your conversation on the TTY/TDD device.

RECEIVE

You may find it helpful to use the vibrating alert under the **Profiles** menu. See "Customize" on page 49 for details.

- 1 Make sure the TTY/TDD device is connected to your phone.
- 2 Press the **Talk** key to answer the call; then type your responses on the TTY/TDD device.

END

Press the **End** key.

• POLYPHONIC SOUND (MIDI)

Your phone is equipped with a polyphonic tone generator capable of playing up to four different voices simultaneously. The generator can reproduce over 40 different instrument tones, including drums, guitar, saxophone, flute, etc. The polyphonic sounds bring a new richness and quality to ringing tones, message alert tones, background music, and sound effects used in gaming.

Your Nokia 3595 mobile phone supports Mobile MIDI (GMX) format messages and ringing tones. Your phone can receive polyphonic ringing tones in two ways:

- Through the multimedia messaging service (MMS). See "Multimedia messages" on page 78 for more information.
- Through the WAP browser. See "Connect" on page 83 for more information.

• RINGING TONES

Download

You can download ringing tones over the Internet or have them sent to your phone by using SMS (short message service) or MMS. MIDI ring tones can be downloaded via MMS or WAP. Traditional ringing tones can be downloaded by using SMS, WAP, and MMS.

Your phone has memory space for several traditional ringing tones or MIDI ringing tones. The number of tones you can save depends on the size of each tone. MIDI tones take up more storage space in the memory than traditional ringing tones.

To download ringing tones, select **Menu > Gallery > Gallery downloads. > Tone downloads. > More bookmarks**. The list of bookmarks is dynamic and may vary, due to network service availability. Check with your service provider for more information.



Note: Methods for downloading ringing tones vary. Some wireless service providers allow you to send ringing tones to your phone over the mobile Internet, but may charge for this service. For details about downloading ringing tones, contact your wireless service provider.

• DISPLAY LANGUAGE

You can select the phone display language.

Select **Menu > Settings > Phone settings > Language** and the language you want.



• WELCOME NOTE

Add

You can add a welcome note that is displayed briefly each time you turn on the phone.

- 1 Select **Menu > Settings > Phone settings > Welcome note**.
- 2 Enter a note and select **Options > Save**.

Delete

- 1 Select **Menu > Settings > Phone settings > Welcome note**.
- 2 Select **Options > Delete**.

• HELP TEXT

Many menu items have brief explanations associated with them. To view the help text, scroll to the menu item and wait for about 30 seconds. Select **More** to see the next page of the text or **Back** to exit.

Select **Menu > Settings > Phone settings > Help text activation > On** or **Off**.

• TIME AND DATE

Your phone has an internal clock that can be displayed on the start screen. It also features an alarm clock. See "Alarm clock" on page 100. The time and date has to be reset each time the phone battery is taken out and replaced.

Set time format

Select **Menu** > **Settings** > **Time and date settings** > **Clock** > **Time format** > **24-hour** or **am/pm**.

Set time

- 1 Select **Menu** > **Settings** > **Time and date settings** > **Clock** > **Set the time**.
- 2 Enter the current time, using two digits for both hours and minutes.
- 3 Select **OK** > **am** or **pm**.

If you entered the time in the 24-hour format, **am** and **pm** do not appear.

Display or hide clock

This feature allows you to either display or hide the time on the start screen.

Select **Menu** > **Settings** > **Time and date settings** > **Clock** > **Hide clock** or **Show clock**.

Set date format

- 1 Select **Menu** > **Settings** > **Time and date settings** > **Date** > **Date format**.
- 2 Select one of the following formats.

DD MM YYYY

MM DD YYYY

YYYY MM DD

Set date

Select **Menu** > **Settings** > **Time and date settings** > **Date** > **Set the date**, enter the date, and select **OK**.

Display or hide date

This feature allows you to either display or hide the date on the start screen.

Select **Menu** > **Settings** > **Time and date settings** > **Date** > **Hide date** or **Show date**.

Set automatic update of date and time

If this feature is supported by your wireless service provider, it automatically updates the clock in your phone in accordance with the current time zone. This may be helpful if you are traveling from New York to California, for example, and want to receive the local time from the wireless network.

Select **Menu** > **Settings** > **Time and date settings** > **Auto-update of date & time** and one of the following options:

On—Updates the date and time automatically.

Confirm first—Requires you to confirm that you want the update.

Off—Prevents the date and time from being automatically updated.

• MEMORY STATUS

Memory information is gathered from the following functions:

- Contacts
- SMS messages
- MMS messages
- Gallery
- Voice recorder
- Organizer
- Applications

1 Select **Menu** > **Settings** > **Phone settings** > **Memory status**.

2 Select **Back** to return to the menu.

You can also check the memory status of **Contacts** while you are in the **Contacts** function. See "Check Contacts memory status" on page 33.

• GALLERY

You can save pictures and ringing tones to an existing folder or a folder you have created in the **Gallery**. You can download images and tones by using SMS, WAP, and MMS and then save them in the **Gallery**. You can find out how much memory is being used by the graphics and ringing tones in the **Gallery** by using the Memory status feature. See "Memory status" on page 56.

Folders

VIEW

This feature allows you to view the folders in the **Gallery**.

- 1 Select **Menu > Gallery > View folders > Graphics or Tones > Open**.
- 2 Select an image or tone, **Options**, and one of the following options:
 - Open**—Allows you to open the selected file.
 - Delete**—Allows you to delete the selected file.
 - Move**—Allows you to move the file to another folder.
 - Rename**—Allows you to rename the selected file.
 - Set as wallpaper/Set as ring tone**—Allows you to set the graphic as wallpaper. In the **Tones** folder, this option is **Set as ring tone**; the tone is applied to profile in use.
 - Details**—Allows you to view details of the file, such as the name, time and date the file was created.
 - Sort**—Allows you to sort the files according to date, format, name, or size.

ADD

This feature allows you to create a folder.

Select **Menu > Gallery > Add folder**, enter a folder name, and select **OK**.

DELETE

This feature allows you to delete a folder you have created.

- 1 Select **Menu > Gallery > Delete folder**.
- 2 Select the folder you want to delete and **Delete > OK**.

RENAME

This feature allows you to rename a folder you have created.

- 1 Select **Menu > Gallery > Rename folder**.
- 2 Select the folder you want to rename and **Rename**.
- 3 Select **Clear** as many times as necessary to delete the current folder name, enter a new folder name, and select **OK**.

• DISPLAY SETTINGS

Wallpaper

You can set your phone to display a background picture (wallpaper) on the start screen. When your phone is shipped from the factory, it will contain some preloaded pictures in the **Gallery**. You can download pictures by using SMS, WAP, and MMS and then save them in the **Gallery**. Your phone supports JPEG, GIF, BMP, PNG, and WBMP formats.

SELECT

- 1 Select **Menu > Settings > Display settings > Wallpaper > Change image**.
- 2 Select **Graphics > Open**, the image you want, and **Options > Set as wallpaper**.

If the wallpaper feature is off when an image is set as a wallpaper, it is switched **On**. You do not need to activate the wallpaper separately.

SET

Select **Menu > Settings > Display settings > Wallpaper > On or Off**.

Color schemes

You can change the color of some display components in your phone, such as indicators and signal bars.

Select **Menu > Settings > Display settings > Color schemes** and the color scheme you want.

Screen saver

You can set your phone to display a screen saver after a preset time or after a custom time (up to 60 minutes). The screen saver is activated when no function of the phone is used after a preset period of time. Press any key to deactivate the screen saver. The screen saver is also deactivated when the phone is out of the network coverage area.

PRESET TIMEOUT

Select **Menu > Settings > Display settings > Screen saver timeout > 2 minutes or 5 minutes**.

CUSTOM TIMEOUT

- 1 Select **Menu > Settings > Display settings > Screen saver timeout > Other**.
- 2 Enter the custom time and select **OK**.

Display brightness

You can change the brightness of the phone display.

- 1 Select **Menu > Settings > Display settings > Display brightness**.
- 2 Press the **Up scroll** or **Down scroll** key to adjust the contrast level and select **OK**.

• CALLER GROUPS

You can create groups of contacts in **Contacts** and give each group a different ringing tone. When someone from that group calls, you will know because of the ringing tone.

Add contact

The name you add to a caller group must first be stored in **Contacts**.

- 1 From the **start** screen, press the **Up scroll** key or the **Down scroll** key to scroll to the name or number you want.
- 2 Select **Details > Options > Caller groups > Family, VIP, Friends, Business or Other**.

Remove contact

- 1 From the start screen, press the **Up scroll** key or the **Down scroll** key to scroll to the name or number you want.
- 2 Select **Details > Options > Caller groups > No group**.

Assign ringing tone

- 1 Select **Contacts > Caller groups** and the group you want.
- 2 Select **Group ringing tone** and the tone you want to hear for this caller group.

You can set your phone to ring only when people from certain caller groups call you and to be silent for all other call groups.

Rename caller group

You can rename any caller group with a name of your own.

- 1 Select **Contacts > Caller groups** and the group you want.
- 2 Select **Rename group**, enter the group name, and select **OK**.

Group graphic

Each caller group can have a picture associated with it. When you get a call from someone in a caller group, the graphic flashes on the screen.

ACTIVATE

- 1 Select **Contacts > Caller groups**, the group you want, and **Group logo**.
- 2 If you want to see the group graphic before you select it, select **View**.
- 3 Select **Back** to return to the menu.
- 4 Select **On**.

DEACTIVATE

Select **Contacts > Caller groups**, the group you want, and **Group logo > Off**.

VIEW A RECEIVED GRAPHIC

When you receive a graphic from someone else, **Group logo received** appears.

To view the graphic, select **Show > Options** and one of the following options:

Save—Allows you to save it (you must select which caller group gets the new graphic).

Discard—Allows you to delete it.

• RESTORE FACTORY SETTINGS

You can use the **Restore factory settings** feature to reset some of the phone settings to their original values.



Note: Restoring factory settings does not delete your list in **Contacts**. However, it does delete all customized settings you may have entered.

Select **Menu > Settings > Restore factory settings**, enter the security code, and select **OK**.

For the default code, see "Security code" on page 67.

• XPRESS-ON™ COLOR COVERS

To personalize your Nokia 3595 mobile phone, you can change the front and back covers. Nokia Xpress-on™ color covers, reactive covers (glow-in-the-dark), and active covers may be purchased from your authorized Nokia dealer.



Note: Before removing the cover, always switch off the power and disconnect the charger and any other device. Avoid touching electronic components while changing the covers. Always store and use the device with the covers attached.

Remove the back cover

- 1 With the back of the phone facing you, press and hold the back cover release button.
- 2 Slide the cover up.
- 3 Lift the cover off the phone.

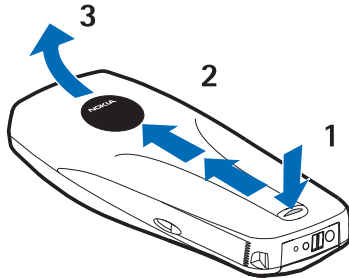

Remove the phone from the front cover

With the back of the phone facing you, gently separate the cover from the phone, starting at the bottom.

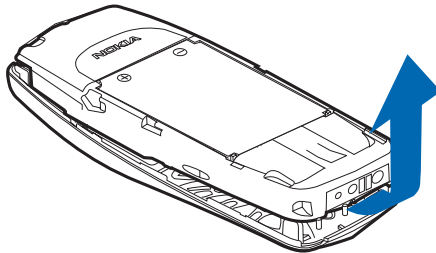

Change the keypad

- 1 Lift the keypad from inside the old front cover.
- 2 Place the keypad into the new front cover.

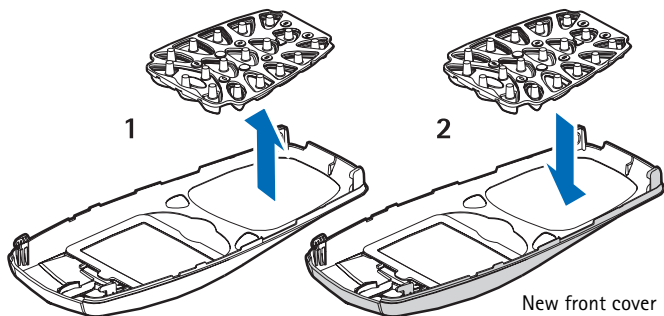

Replace the new front cover

- 1 To replace the front cover, align the top of the phone with the top of the front cover. Make sure both sets of plastic tabs line up with their slots, as shown at right.
- 2 Align the cover and snap it shut all the way around the edge of the phone.

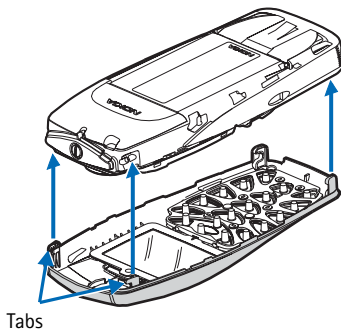

Replace the back cover

- 1 Direct the back cover towards the locking catches on the phone.
- 2 Slide the back cover until it locks into place.

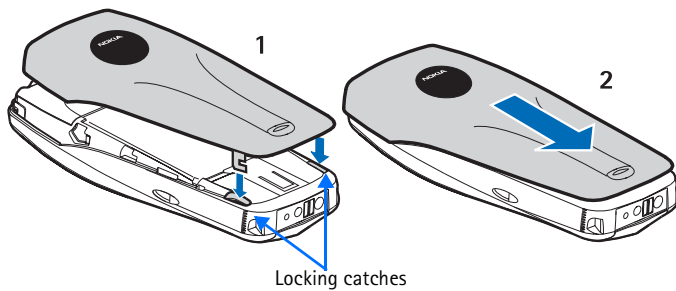

13 Phone security

Your phone is equipped with different security features that allow you to do the following:

- Avoid making accidental calls
- Prevent unauthorized use of your phone
- Restrict outgoing or incoming calls

• LOCK THE KEYPAD (KEYGUARD)

The keyguard disables your keypad to prevent accidental key presses (for example, when your phone is in your pocket or purse).

- To lock the keys, select **Menu** and press the * key.
- To unlock the keys, select **Unlock** and press the * key.



Note: When the keyguard is enabled, the keypad and display cannot light if you press a key. Press the **Power** key briefly to activate the keypad and display lights.

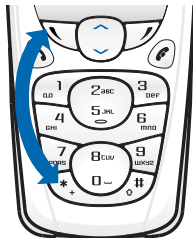

Automatic keyguard

You can have your phone automatically lock the keys after a time you specify.

- 1 Select **Menu** > **Settings** > **Phone settings** > **Automatic keyguard** > **On**.
- 2 Enter the delay time and select **OK**.

When the keyguard is on, calls still may be possible to the official emergency number programmed into your phone. Enter the emergency number and press the **Talk** key.

• SECURITY CODES

The table on the next page summarizes how different types of security codes are used in your phone.

Code	Purpose
Security code	<p>Use the security code for the following procedures:</p> <ul style="list-style-type: none"> • Reset call timers (page 36) • Clear the data counter (page 38) • Clear the connection timer (page 38) • Restore factory settings (page 60) • Delete your entire contact list (page 34) <p>If phone security is on, the phone requests the security code the first time you use it after installing a new SIM card.</p>
PIN code	<p>You can use the PIN code to protect against unauthorized calls if the following conditions are met:</p> <ul style="list-style-type: none"> • The PIN code request is turned on • The phone is powered off <p>The next time the phone is turned on, you must enter the correct PIN code to make calls or use the menus.</p>
PIN2 code	<p>Enter the PIN2 code for the following procedure:</p> <p>Set up or change fixed dialing numbers (page 67)</p>
Restriction password	<p>Required by the restrict calls feature.</p>

• PIN CODES

The PIN and PIN2 codes are 4-digit to 8-digit numbers that usually come from your service provider along with the SIM card. Use the PIN code to protect your phone and SIM card against unauthorized use. The PIN2 code activates some phone functions, such as call cost limit. See "Manage call costs" on page 37.

When the phone requires the PIN or PIN2 code, it displays **Enter PIN code** or **Enter PIN2 code**.

Enter the code and select **OK**.

PIN code request

You can activate the PIN code request to prevent unauthorized use of your phone. If you set the PIN code request to **On**, your phone will ask for the code each time you turn the phone on. When the phone is locked, calls still may be possible to the official emergency number programmed into your phone.

ACTIVATE

- 1 Select **Menu > Settings > Security settings > PIN code request**.
- 2 Enter the PIN code supplied by your service provider and select **OK > On > OK**.

DEACTIVATE

- 1 Select **Menu > Settings > Security settings > PIN code request**.
- 2 Enter the PIN code supplied by your service provider and select **OK > Off > OK**.

Change

You can change your PIN or PIN2 code to any 4-digit to 8-digit number. You must activate the PIN code request first. See "PIN code request" on page 66.

- 1 Select **Menu > Settings > Security settings > Change access codes > Change PIN code**.
- 2 Enter the current PIN code, select **OK**, enter the new PIN code, and select **OK**.
- 3 Enter the new PIN code again to verify and select **OK**.



Note: If you make a mistake while entering the code, **Code Error** appears. Start again at step 2 and be careful to enter the correct code. If you enter the wrong code three times in a row, the PIN code is blocked. To unblock the PIN code, you need a personal unblocking key (PUK) from your service provider.

• PUK CODES

The PUK and PUK2 codes are 4-digit to 8-digit codes that usually come from your service provider along with the SIM card. The PUK code unblocks a blocked PIN code, and the PUK2 code unblocks a blocked PIN2 code.

If you block your phone, contact your service provider. When you enter the PUK code given by your service provider, the phone prompts you to enter and then confirm a new PIN code.

• SECURITY CODE

The default security code is 12345. Nokia recommends that you change the default code immediately.

You need the security code to access certain phone features. When the phone requires the security code, it displays **Security code**. Enter the code and select **OK**.

If you enter an incorrect security code five times in a row, the phone will not accept the correct code for five minutes.

Change the security code

- 1 Select **Menu > Settings > Security settings > Change access codes > Change security code**.
- 2 Enter the current security code, select **OK**, enter the new security code, and select **OK**.
- 3 Enter the security code again to verify and select **OK**.



Important: Keep the code secret and in a safe place, separate from the phone.

• FIXED DIALING

If supported by your SIM card, this feature lets you restrict your outgoing calls to phone numbers included in the fixed dialing list or beginning with the same digits as an entry in the list. When fixed dialing is activated, calls still may be possible to the official emergency number programmed into your phone.

- 1 Select **Menu > Settings > Security settings > Fixed dialing > On or Off**.
- 2 Enter your PIN2 code and select **OK**.

Add numbers to list

- 1 Select **Menu > Settings > Security settings > Fixed dialing > Number list**.
- 2 Select **Add**, enter your PIN2 code, and select **OK**.
- 3 Enter a name to go with the restricted phone number and select **OK**.
- 4 Enter the phone number you want to restrict and select **OK**.
- 5 Repeat steps 2–4 for each number you want to add to the list.

• RESTRICT CALLS

This network service, if available from your service provider, lets you restrict the calls your phone can make and receive. Check with your service provider for details. When calls are restricted, calls still may be possible to the official emergency number programmed into your phone. Contact your service provider for the restriction password.

Turn on call restrictions

- 1 Select **Menu > Settings > Security settings > Call restrictions** and one of the following options:

Outgoing calls—Calls cannot be made.

International calls—Calls cannot be made to foreign countries.

International except to home country—When abroad, calls can be made only within the current country and to your home country (that is, the country where your home network operator is located).

Incoming calls—Calls cannot be received.

Incoming calls if roaming—Calls cannot be received outside your home area.

Cancel all call restrictions—Turns off all call restrictions. Calls can be made and received in the usual way.



Note: If you select **Cancel all call restrictions**, the following steps are not available. Also, you can cancel call restrictions on each option, allowing restrictions on other options to stay in force.

- 2 After you have selected one of the above options, select one of the following options:

Activate—Enter the restriction password and select **OK**.

Cancel—Enter the restriction password and select **OK**.

Check status—View the call types with call restriction active.

Change your restriction password

- 1 Select **Menu > Settings > Security settings > Change restriction password**.
- 2 Enter your current password and select **OK**.
- 3 Enter your new password, select **OK**, verify the new password, and select **OK**.

- **CLOSED USER GROUPS**

This network service, if available from your service provider, specifies the group of people to whom you can call and who can call you. **Default** resets the phone to use a user group that the SIM card owner has agreed upon with the service provider. When calls are limited to closed user groups, calls still may be possible to the official emergency number programmed into your phone.

Select **Menu > Settings > Security settings > Closed user group > On** or **Off**, enter the group number, and select **OK**.

14 Mobile messages

You can use mobile messages to keep in touch with friends, family, and business associates. Your Nokia 3595 mobile phone allows you to do the following:

- Send and receive text messages
- Communicate through e-mail
- Communicate online with other phone users
- Compose, send, receive and view multimedia messages (MMS)
- Send and receive picture messages

Not all messaging features are available in all wireless networks. Contact your service provider for availability and subscription information.



• MESSAGE SETTINGS

Before you can send and receive messages you must:

- Have a text messaging subscription through your service provider.
- Contact your service provider for the message center number.
- Save your message center number in your phone.
- Set up other message settings, such as GPRS.

Save your message center number

- 1 Select **Menu > Messages > Message settings > Text messages > Sending profile.**
- 2 If your SIM supports more than one message profile, select a profile and **Message center number.**
- 3 Enter your message center number and select **OK.**

Set the message mode

You can choose the type of message sent by your phone. The message modes include text, e-mail, fax and page. This feature appears only if your SIM card supports multiple message types.

- 1 Select **Menu > Messages > Message settings > Text messages > Sending profile.**
- 2 If your SIM supports more than one message profile, select a profile and **Messages sent as > Text, E-mail, Page, or Fax.**

In order to receive a converted message, the recipient needs to have the appropriate terminal device, such as a pager or fax machine. E-mail messages can be sent to a mobile phone or personal computer.

Adjust font size

You can modify the font size for message displays. The font size you select appears in messages when you are reading or editing and in message lists.

Select **Menu > Messages > Message settings > Other settings > Font size > Small font** or **Large font**.

Other message settings

You can modify the other **Sending profile** message settings. The following list is dynamic. The order and number of items may vary, due to the SIM card configuration and network service availability. Check with your service provider for more information. To modify the other **Sending profile** message settings, select **Messages > Message settings > Text messages > Sending profile** and one of the following options:

Message validity—Allows you to select the length of time that the message center will try to deliver a message. You can choose a time from one hour to one week. If the message center cannot deliver the message within this time, the message is deleted.

Default recipient no.—Allows you to specify a single recipient for all your messages. This option is not available when you choose **Messages sent as e-mail**.

E-mail server—Allows you to store e-mail server information in your phone so that you do not have to enter the number each time you compose a new e-mail message. This option only shows up if you have set the message mode to **E-mail**. Contact your service provider for the server number.

Delivery reports—Allows you to ask the network for a report about message delivery.

Use GPRS—Allows you to send your messages through GPRS.

Reply via same center—Allows you to direct the recipient to reply through the same message center. Do not select **Yes** unless you know the recipient has the same service provider.

Rename sending profile—Allows you to name the profile. This option depends on SIM card and is not available for the **Default** profile.

• TEXT MESSAGES

You can use the text message feature to compose and send a short text message to another phone. Your device supports the sending of text messages beyond the normal 160-character limit. If your message exceeds 160 characters, it will be sent as a series of two or more messages. In the navigation bar, you can see the message length indicator counting backwards from 160. For example, 10 (2) means that you can still add 10 characters for the text to be sent as two messages.

Using special (Unicode) characters, such as ã, â, á, ì, takes up more space. If there are special characters in your message, the indicator may not show the message length correctly. Before the message is sent, the device tells you if the message exceeds the maximum length allowed for one message. You can cancel sending by selecting **Cancel** or you can save the message in the inbox.

Send

- 1 Select **Menu > Messages > Text messages > Create message**.
- 2 Compose a message and select **Options > Send**.
- 3 Enter the recipient's phone number and select **OK**.

If you need to exit while writing the message, press the **End** key anytime. Later, select **Menu > Messages > Text messages > Create message** to return and finish writing the message. If you turn off the phone without saving the message, the message will be lost.

When sending messages, your device may display the words **Message Sent**. This is an indication that the message has been sent by your device to the message center number programmed into your device. This is not an indication that the message has been received at the intended destination. For more details about messaging services, check with your service provider.

Send to multiple recipients

You can send the same message to more than one recipient. Before using this feature, the names of your recipients must be entered into **Contacts**. See "Save names, numbers, and e-mail addresses" on page 30.

- 1 From the message screen, select **Options > Sending options > Send to many**.
- 2 Select the person's name and **Send**.
- 3 To add other names to the message, repeat step 2.

Read

When you receive a text message, the phone beeps and the  icon and **n message(s) received** appears, where **n** is the number of messages.

To read the message now, select **Show**.

Read a new text message later

- 1 When you receive a text message, select **Exit**.
- 2 When you want to read the message, select **Menu > Messages > Text messages > Inbox**.

A list of message headers is displayed.



Indicates that a text message has been read.



Indicates that a text message has *not* been read.

- 3 Select the message you want to read.
- 4 If the message is long, use the scroll keys to scroll through the message.

Read linked messages

Your phone can receive one long message (up to 459 characters) in sequences. You can start reading the first part before the phone has received the entire message. While viewing the message, you may see ***some text missing*** on the display. This is normal and the message content will be updated, as soon as the missing sequence arrives.

If the memory is full, you may have to delete a message from your **Inbox** before your phone can update the missing text.

Text message options

While reading or viewing a message, you can select one of the following options. The following list is dynamic and the order and number of options may vary.

Delete—Allows you to delete the message.

Reply—Allows you to start your reply with an empty screen, a template, or with standard replies like **Yes**, **No**, **Thank you**, or **Congrats**.

Use detail—Allows you to extract phone numbers, e-mail addresses, or web addresses from the current message. The phone goes through and gathers all phone numbers, e-mail addresses or web addresses in the message, including the originating number or address.

Forward—Allows you to send the message to another recipient.

Edit—Allows you to modify the message.

Move—Allows you to move the message to the **Templates** or **Archive** folder, for example.

Rename—Allows you to enter a new title for the message.

Copy to calend.—Allows you to copy the message to the phone calendar as a reminder note. This option is not available for picture messages.

Message details—Allows you to view the details of the message, like the sender's name and phone number, reception date and time.

Save picture—Allows you to save a picture to the template folder. This option only appears in the list if you receive a picture message.

• E-MAIL MESSAGES

You can send e-mail messages to friends and family directly from your phone if you sign up for this service with your service provider. There are two ways of sending an e-mail message.

- You can send an e-mail message from the **Messages** menu.
- You can send an e-mail message from **Contacts**.

Before you send e-mail messages, you can set up a profile to define the e-mail server. Contact your service provider for the e-mail server number.

Define an e-mail sending profile

If you use the e-mail feature on a regular basis, you may find it helpful to define an e-mail sending profile. This feature depends on your SIM card. Contact your service provide for more information about e-mail profiles.

- 1 Select **Menu > Messages > Message settings > Text messages > Sending profile**.
- 2 If your SIM card supports more than one message profile, select a profile.
- 3 If your SIM card already has a profile called **E-mail**, go to step 5.
- 4 Select **Messages sent as > E-mail**.
- 5 Enter the e-mail server number, select **Options > Accept**.

Send

FROM THE MESSAGES MENU

- 1 Select **Menu > Messages > Text messages > Create SMS e-mail**.
- 2 Enter the e-mail address, select **OK**, enter a subject, and select **OK**.
- 3 Enter a message and select **Options > Send e-mail**.
- 4 If you have not defined an e-mail sending profile, enter the e-mail server number, then select **OK**.

FROM CONTACTS

First you must have an e-mail address for the person entered into **Contacts**. See "Save names, numbers, and e-mail addresses" on page 30.

- 1 At the start screen, press the **Up scroll** or **Down scroll** key to scroll to the name to whom you want to send an e-mail message.
- 2 Select **Details** and the e-mail address.
- 3 Select **Options > Send e-mail**.
- 4 Enter a subject, select **OK**, enter a message, and select **Options > Send e-mail**.
- 5 If you have not defined an e-mail sending profile, enter the e-mail server number and select **OK**.

Receive

When you receive an e-mail message, the phone beeps and the  icon and **n message(s) received** appears, where **n** is the number of messages.

To read the message now, select **Show**.

When reading a received e-mail message, you can choose other options, such as **Reply** or **Forward**. See "Text message options" on page 73 for a list of options.

• STORE MESSAGES

Preset folders

There are preset folders in your phone.

INBOX

Messages are automatically stored in the **Inbox** folder after they have been read or if you press the **End** key when **message received** appears on the **start** screen.

SENT ITEMS

You can use the **Sent items** folder to store saved messages.

ARCHIVE

To make sure that certain messages will not be overwritten when memory becomes full, move some of your messages to the **Archive** folder.

TEMPLATES

Pictures and prewritten templates are stored in the **Templates** folder.

From the message screen, select **Options > Use template** and the template you want.

My folders

Keep your messages organized by creating custom folders and saving your messages there.

ADD

Select **Menu > Messages > Text messages > My folders > Add**, enter a name for the new folder, and select **OK**.

DELETE

Only folders created in **My folders** can be deleted. The **Inbox**, **Sent items**, **Archive**, and **Templates** folders are protected. When you delete a folder, all messages in the folder are deleted as well.

- 1 Select **Menu > Messages > Text messages > My folders** and the folder you want to delete.
- 2 Select **Options > Delete folder > OK**.

Move a message to a folder

While viewing the message, select **Options > Move** and the destination folder you want.

• DELETE MESSAGES

If your message memory becomes full, the message icon blinks in the display. You can do the following to create more space:

- Read some of the unread messages and then delete them.
- Delete some of these messages from your folders.

Single

To delete a single message, you need to open it first.

- 1 Select **Menu > Messages > Text messages** and the folder containing the message you want to delete.
- 2 Select the message you want to delete and **Options > Delete > OK**.

All messages in folders

- 1 Select **Menu > Messages > Text messages > Delete messages**.
- 2 Select the folder or message type that you want to delete and **OK**.

• PICTURE MESSAGES

Picture messages are like picture postcards. You can add text to the postcard before sending the message to a friend who has a compatible phone. You can find pictures under **Menu > Messages > Text messages > Templates**.

Notes

- This function can be used only if it is supported by your network operator or service provider. Only phones that offer picture message features can receive and display a picture message.
- Your phone has two types of pictures available—graphic icons found in the **Templates** folder and images found in the **Gallery**. The pictures found in the **Templates** folder are black and white, the images found in the **Gallery** are color, and both display in the body of the message. A picture message can only be sent to a phone number, while a **Gallery** image can be sent as a multimedia message (requires a GPRS connection) to either a phone number or an e-mail address.
- Each picture message is made up of several text messages. Therefore, sending one picture message may cost more than sending one text message. Contact your service provider for pricing information.
- Since pictures are saved in the phone memory, you cannot view them if you use your SIM card with another phone.
- Before sending a picture message, be sure to set the message mode to **Text**. See "Set the message mode" on page 70.

Send

- 1 Select **Menu > Messages > Text messages > Templates** and the picture you want to send.
- 2 Select **Options > Send > As text msg.**, enter the phone number, and select **OK**.

Attach a picture to a text message

- 1 Select **Menu > Messages > Text messages > Create message**.
- 2 Compose a message, select **Options > Insert picture** and the picture you want to send.
- 3 Select **View > Insert > Options > Send**, enter the phone number, and select **OK**.

Receive

When you receive a picture message, the phone beeps and the  icon and **n message(s) received** appears, where **n** is the number of messages.

To read the message now, select **Show**.

Read later

- 1 After you have received a message and you want to read it later, select **Exit**.
- 2 When you want to read the message, select **Menu > Messages > Text messages > Inbox** and select the message you want.

Save

- 1 While viewing the message, select **Options > Save picture**.
- 2 Enter a title for the picture and select **OK**.
The picture is saved to the **Templates** folder.

Save picture messages with edited text

- 1 While viewing the message, select **Options > Edit text > As text msg.** and make changes to the text.
- 2 Select **Options > Save message > Archive** or **Templates**.
- 3 If the phone prompts you to replace the original message, select **Yes**.

• MULTIMEDIA MESSAGES

This is a Network Service.



Note: Only devices that offer compatible multimedia message or e-mail features can receive and display multimedia messages. Multimedia message objects may contain viruses or otherwise be harmful to your device or PC. Do not open any attachment if you are not sure of the trustworthiness of the sender.

A multimedia message can contain text, images, and sounds. Your phone has a multimedia message viewer for playing messages and a multimedia inbox for storing saved messages. Once you save the multimedia message, you can use the image as wallpaper or the sound as a ringing tone.

This function can be used only if it is supported by your network operator or service provider. Only devices that offer compatible multimedia message or e-mail features can receive and display multimedia messages.

Message receiving limitations

Your phone can receive a multimedia message under the following conditions:

- The message size is under 45 KB.
- The message type and settings allow reception.

Define settings

Before you can use the multimedia messaging service (MMS) feature, you need to define the way you want to receive the messages. The default setting of the multimedia messaging service is generally on.

The appearance of a multimedia message may vary, depending on the receiving device.

ALLOW MULTIMEDIA MESSAGES

You can choose to receive all messages or to receive messages only when you are in the service provider's home network.

- 1 Select **Menu > Messages > Message settings > Multimedia msg. > Allow multimedia reception** and one of the following options:

Yes—Allows all incoming messages to be received.

In home system—Allows incoming messages to be received only if you are in the service provider's home system.

- 2 Select **Incoming multimedia messages > Retrieve**.

BLOCK MULTIMEDIA MESSAGES

You can choose to not receive any multimedia messages.

Select **Menu > Messages > Message settings > Multimedia msg. > Allow multimedia reception > No**.

ADVERTISEMENTS

Select **Menu > Messages > Message settings > Multimedia msg. > Allow advertisements > Yes or No**.

CONNECTION SETTINGS

Contact your service provider for information about downloading appropriate connection sets for MMS.

Write and send

- 1 Select **Messages > Multimedia messages > Create message**.
- 2 Enter the text of your message and select **Options**.
- 3 To insert a picture or a sound clip, select **Insert image** or **Insert sound**, respectively, then open the folder you want, select the picture or sound clip, and **Options > Insert**.
- 4 To insert a name from **Contacts**, select **Options > More options > Insert contact**, the name you want, and **Options > Insert contact**.
- 5 To insert a number, select **Options > More options > Insert number**, enter the number or search for it in **Contacts**, and select **OK**.
- 6 To view the message before sending it, select **Options > Preview**.
- 7 To send the message, select **Options > Send to number** or **Send to e-mail**.
- 8 Enter the recipient's number or e-mail address, or search for it in **Contacts**, and select **OK**.

It takes more time to send a multimedia message than to send a text message. While the multimedia message is being sent, the animated icon  is displayed and you can use other functions on the phone. If there is an interruption while the message is being sent, the phone tries to resend it a few times. If this fails, the message will remain in the **Outbox** folder and you can try to resend it later.

Read

When you receive a multimedia message, the phone beeps and displays **Multimedia message received**.

To read the message now, select **Show**. You can use the scroll keys to view the different elements of the message, for example, text, images, or MIDI tones.

Read later

To read the message later, select **Exit**.

Options

While viewing a message, select **Options** and one of the following options. The following list is dynamic and the order and number of options may vary.

Details—Allows you to view details of the file, such as the name, size, date, time, resolution, format, and copyright.

Save image—Allows you to save the image when the graphic part of the multimedia message is active. The image is saved under **Messages > Pictures**.

Delete message—Allows you to delete a saved multimedia message.

Reply—Reply to the sender of the message.

Forward to no.—Forward the message to another number.

Fwd. to e-mail—Forward the message to an e-mail address.

Message details—View the message's sender, recipient(s), time, date, subject, size, and type.

Play—Allows you to play the ringing tone when the sound clip part of the multimedia message is active.

Save sound—Allows you to save the ringing tone when the sound clip part of the multimedia message is active. The tone is saved under the ringing tone list. See "Customize" on page 55 for information about selecting a ringing tone.

• INFO MESSAGE SERVICE

With the info message network service, you can receive short text messages on various topics, such as weather and traffic conditions, from your service provider. Info message selections can be found under **Menu > Messages > Info messages**. For available topics and relevant topic numbers, contact your service provider.

• SERVICE COMMAND EDITOR

Use the **Service command editor** (found under **Menu > Messages > Service command editor**) to key in and send service requests (also known as USSD commands) to your service provider. For more information, contact your service provider.

15 Mobile Internet

Your phone has a built-in browser you can use to connect to selected services on the mobile Internet. You can view weather reports, check news or flight times, view financial information, make online purchases and much more.



• NOTES ABOUT THE MOBILE INTERNET

A technology called wireless application protocol (WAP) is to mobile devices what the World Wide Web (WWW) is to personal computers. Internet content on your personal computer is called a "web page." Internet content on your mobile phone is called a "page," "WAP card," or a "Deck of cards." If the WAP site designer has made a page too large to load on the phone, it will not be displayed in the browser. You will see an error message saying, "File too big to be loaded" and the browser will return to the previous page.

GPRS

GPRS is a technology used to send and receive data using short bursts or packets over the wireless network. GPRS allows you to stay connected to the mobile Internet. This feature allows for faster downloads of information and no time spent completing a dial-up connection. Applications using GPRS include the WAP browser and text messaging.

- For information about how to track time spent online, see "Data calls" on page 38.
- For information about sending messages using GPRS, see the entry for **Use GPRS** under "Other message settings" on page 71.
- For availability, pricing, and subscription to GPRS services, contact your service provider.

Service provider

Because mobile Internet content is designed to be viewed from your phone, your wireless service provider now becomes your mobile Internet service provider, as well.

It is likely that your service provider has created a home page and set up your browser to go to this page when you log on to the mobile Internet. Once you are at your service provider's home page, you will find links to a number of other sites.

• SET UP FOR BROWSING

You should not need to do anything to set up your phone for browsing. Your service provider usually modifies the appropriate settings when you subscribe to the feature. Contact your service provider if you have problems using the browser.

• CONNECT

Use the **Services** menu to connect to the mobile Internet and to your service provider's home page. Select **Menu > Services > Home**.

If you see an error message, the phone may not be set up for browsing. Contact your service provider to make sure that your phone is configured properly.

• BROWSER OPTIONS

The **Services** menu gives you the options shown in the following list. Some service providers may have customized the options on the **Services** menu. Contact your service provider for more information if any of the options shown here are not available.

Home—Starts the browser and takes you to your service provider's home page.

Bookmarks—Shows a list of all saved bookmarks. Bookmarks help you find a WAP site quickly.

Service inbox—Allows you to receive notifications from your service provider. Notifications may be about new e-mail messages, changes in stock prices or news headlines.

Settings—Provides options for changing connection settings, appearance settings, and authority certificate.

Go to address—Accepts an address you enter.

Clear the cache—Empties the browser's temporary memory and frees up space. It is advisable to empty your cache at the end of each session.

• NAVIGATE

Since the phone screen is much smaller than a computer screen, mobile Internet content is displayed in a different format than you may be used to seeing. This section shows simple guidelines for using the phone keys to navigate a WAP site and examples of how to read a WAP site.

Phone keys

- Use the **Up scroll** and **Down scroll** keys for vertical browsing.
- Use the **4** and **6** keys for horizontal browsing. To set up these keys for horizontal browsing, select **Menu > Services > Settings > Appearance settings > Scroll mode > Numeric keys**.
- To select a highlighted item, press the **Talk** key.
- To enter letters and numbers, press the **0-9** keys.
- To enter special characters, press the ***** key.

Examples of mobile Internet sites

The following illustrations show most of the elements you may find on a mobile Internet site. These are examples only.

1) **Header line** shows the current mobile Internet site.

2) **Inactive link** appears as an underlined word.

3) **Active link** appears as a highlighted word.



Use the **Scroll up** and **Down scroll** keys to scroll through the list of links.

1) **Selection list**—Brackets [] appear when you have the option to enter information.

2) **Options**—Select **Options** to go to the site's menu and/or browser page.

3) **Back**—Select **Back** to return to the previous page.

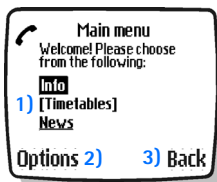

Data entry field—Brackets [] around three dots appear when you need to enter information. In this example, you can enter your zip code to receive the local weather forecast.

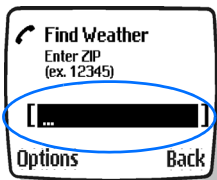

• BOOKMARKS

You can save addresses for your favorite sites as bookmarks. A bookmark helps you find a site again, just as a slip of paper helps you find a page in a book. Your device may have some bookmarks loaded for sites not affiliated with Nokia. Nokia does not warrant or endorse these sites. If you choose to access them, you should take the same precautions for security or content as you would with any Internet site.

Add

You can add up to 30 bookmarks.

- 1 Select **Menu > Services > Bookmarks > Options > New bookmark.**
- 2 Enter the address, select **OK**, enter a title, and select **OK.**

You can set a bookmark to mobile.nokiausa.com, which gives you access to downloadable Java games, graphics, and ringing tones, if your service provider supports this feature. Contact your service provider for details.

Add while browsing

Select **Menu > Services > Bookmarks > Options > Add bookmark.**

• SECURITY ISSUES

Empty the cache

A cache is a memory location that is used to store data temporarily. If you have tried to access or have accessed confidential information requiring passwords, empty the cache after each use. The information or services you have accessed are stored in the cache.

FROM THE MENU

Select **Menu > Services > Clear the cache.**

WHILE BROWSING

Select **Options > Clear the cache.**

Authority certificates





To use some WAP services, such as banking services, you need an authority certificate. Using the certificate can help you to improve the security of connections between your phone and a WAP server.

You can download the certificate from a WAP page if the WAP service supports the use of authority certificates. After the download, you can view the certificate, then save or delete it. If you save the certificate, it is added to the list of certificates in the phone. Your phone alerts you if the identity of the WAP server or WAP gateway cannot be verified or is not authentic.

To view the list of authority certificates, select **Menu > Services > Settings > Certificates > Authority certificates > Certificate list**.

• GPRS

In order to use GPRS, you must first subscribe to the network service. Contact your service provider for details. When you use GPRS to connect to the mobile Internet, you are making a data call. The following icons appear on the screen to show you the status of your connection.

	Appears in the left upper corner of the screen; indicates an active GPRS connection, for example, when you are using the WAP browser
	May appear in the left lower corner of the screen, under the signal strength bars, indicating a continuous GPRS connection, if you choose the Always online setting
	Indicates that circuit switched (CS) or voice calls are not possible when using GPRS for a data call
	Indicates that the GPRS connection has been interrupted by a voice call

Set up the connection

Some service providers may have customized the options on the **Services** menu. Contact your service provider for more information if the options shown here are not available. GPRS may not be available in all wireless networks. The establishment and continuation of a GPRS and mobile Internet connection depends on network availability, service provider support, and signal strength.

You can choose one of the following options from **Menu > Services > Settings > Edit active service settings > GPRS connection**:

Always online—The GPRS connection is established when you turn your phone on. The connection continues in the background even after you exit the WAP browser, depending on network coverage.

When needed—The GPRS connection is established when you use the WAP browser and is closed when you exit the WAP browser.

The following options shows how to end your browsing session, depending on which option you have chosen for your GPRS connection.

- Press the **End** key to return to the start screen if you have selected **Always online**. The GPRS connection remains in the background.
- Press the **End** key to end the GPRS connection if you have selected **When needed**.
- Press the **End** key twice to return to the start screen if you have selected **When needed**.
- Press and hold the **End** key to end browsing and disconnect from GPRS if you have selected **When needed**.

Receive a call while online

If you are using the WAP browser over GPRS, you can still receive a voice call. Your data call is put on hold and you can choose to answer the call.

- To answer the incoming call, press the **Talk** key.
- To reject the incoming call, press the **End** key.

After you end your voice call, the GPRS connection automatically resumes.

Make a call while online

When you are browsing a WAP card and want to make a call to a number on the WAP page, you can select **Use number**. Your phone then searches the information on the WAP card for a string of numbers. You can then choose from the number or numbers displayed to place the call.

An alternate way is to press the **End** key to disconnect from the mobile Internet, then place your call by searching **Contacts** for a name and number or by keying in the phone number.

Make an emergency call while online

If you are using GPRS to connect to the mobile Internet, you can end your data connection and then make an emergency call.

- 1 To close your mobile Internet connection, simply press the **End** key twice.
- 2 Enter the emergency number for your present location (for example, 911).
- 3 Press the **Talk** key.

- **DISCONNECT**

Select **Options > Quit > Yes**.

OR

Press the **End** key twice.

16 Instant messaging (IM)

Take text messaging to the next level by experiencing instant messaging in a wireless environment. Engage in instant messaging (IM) with friends and family, as long as you all use the same IM service. Check with your wireless service provider for availability.

Before you can start using IM on your phone, you must first subscribe to your wireless service provider's text messaging service. While only SMS capability is required to use the service, GPRS improves the speed of instant messaging. You must also register with the IM service you want to use. See "Register with an IM service" on page 90 for more information.

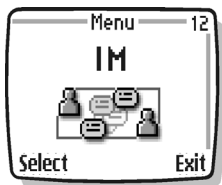



Note: Due to variations in IM and wireless service providers, you may not have access to all of the features described in this guide.

• IM SERVICE PROVIDER ICONS

Since each IM service has its own display text and icons associated with it, the display text and icons on your phone may appear differently for each IM service provider. If you have any questions about the differences in the various IM service providers' display text and icons, contact your wireless service provider for more information. The following table shows examples of IM icons and their descriptions:

Icon	Description
	Available for all
	Available for contacts/Do not disturb
	Appear offline
	Available with an alert set
	Offline with an alert set
	Blocked contact

Icon	Description
	Unread message/New message
	Read message
	Group invitation

• REGISTER WITH AN IM SERVICE

Before you can begin to use IM, you must register with an IM service to obtain an IM user name and password. You can obtain an IM user name and password by registering over the Internet (using your computer) with the IM service provider you have selected to use. During the registration process, you will have the opportunity to create the user name and password of your choice. For more information about signing up for IM services, contact your wireless service provider.

• IM MENUS

Offline

Before you log into IM, the IM menu appears as follows:

Login

Saved convers.

IM provider

Settings

Online

After you log into IM, the IM menu appears as follows:

Conversations

IM contacts

Add contact

Group convers.

IM availability

Saved convers.

Settings

Blocked list

Logout

• LOG IN

The first time you use IM, you need to enter your user name.

Every time you log in, you need to select the **IM provider** you want to use and you will receive screen prompts for your user name and password. You do not have to manually enter your user name after the first login; however, you must manually enter your password every time you log in.

First time login

- 1 Select **Menu > IM > Login** and your IM service provider.
- 2 Enter your user name and select **Options > OK**.
- 3 Enter your password and select **Options > OK**.

After first time login

- 1 Select **Menu > IM > Login** and your IM service provider.

The **User ID** screen appears with your user name.

- 2 Select **Options > OK**, enter your password, and select **Options > OK**.

After you have logged into IM initially, you have the option of a manual login or an automatic login. See "Automatic login" on page 96 for information on setting up automatic login.

• SET YOUR AVAILABILITY

You can determine if other users can tell whether you are available or not.

From the IM online menu, select **IM availability** and one of the following options:

Available for all—All other users see your status as online and you receive availability information and messages from all other users.

Avail. for cont.—Even though just the contacts in **IM contacts** see your status as online, you receive availability information and messages from all other users.

Appear offline—Even though all other users see your status as offline, you receive availability information and messages from all other users.

• IM CONVERSATIONS

You can send instant messages to anyone who uses the same IM service as you do and if you have that person's user name. You can also add that person to **IM contacts** during an IM conversation. See "IM contacts" on page 93 for more information. More than one IM conversation can be active at the same time.

Conversation view

The conversation view of your IM conversation shows your initial message at the bottom of the screen, followed by the reply. As the conversation progresses, the most recent message appears at the top of the screen, causing the last message to move down one level.

The conversation is still active, even if you leave the conversation view. You can return to it when you want.

- 1 From the IM online menu, select **Conversations**.
- 2 Select the IM conversation you want and **Open**.

Write and send

- 1 From the IM online menu, select **IM contacts > Select > Write to other**.
- 2 Enter the user name of the person to whom you want to send an instant message and select **Options > OK**.
- 3 Select **Options > Write**, enter a message, and select **Options > Send**.

Write and send to contact

- 1 From the IM online menu, select **IM contacts** and the contact to whom you want to send a message.
- 2 Select **Chat > Options > Write**, enter a message, and select **Options > Send**.

Receive and reply

IN CONVERSATION VIEW

When you receive an instant message, your phone beeps and the sender's reply appears above your most recent message.

Select **Options > Write**, enter a message, and select **Options > Send**.

OUTSIDE CONVERSATION VIEW

When you receive an instant message, your phone beeps, and a screen with the sender's screen name appears, notifying you that you have received an instant message.

Select **Open > Options > Write**, enter a message, and select **Options > Send**.

Save

- 1 From the conversation view, select **Options > Save**.
- 2 Keep the conversation name that appears in the display and select **Options > Save**.
OR
Select **Clear** as many times as necessary to delete the conversation name, enter the name you want, and select **Options > Save**.

View

From either the IM online or offline menu, select **Saved convers.**, and the conversation you want to view.

Rename

- 1 From either the IM online or offline menu, select **Saved convers.**, the conversation you want to rename, and **Options > Rename**.
- 2 Select **Clear** as many times as necessary to delete the conversation name; then enter the new conversation name.
- 3 Select **Options > OK**.

Delete

From either the IM online or offline menu, select **Saved convers.**, the conversation you want to delete, and **Options > Delete**.

End

IN CONVERSATION VIEW

Select **Back**, the conversation you want to end, and **End convers.**

OUTSIDE CONVERSATION VIEW

From the IM online menu, select **Conversations**, the IM conversation you want to end, and **End convers.**

• IM CONTACTS

Add the names of your friends and family (with whom you want to interact frequently through IM) to **IM contacts**.

Add

- 1 From the IM online menu, select **Add contact**.
- 2 Enter the contact's user name, select **Options > OK**.
The **Nickname** screen appears with the contact's user name. If you want to enter a nickname by which to identify the contact, select **Clear** as many times as necessary to delete the user name. Then, enter the nickname. This is the name that appears in **IM contacts**.
- 3 Select **Options > OK**.

DURING IM SESSION

- 1 From the conversation view, select **Options > Add**.
The **User ID** screen appears with the contact's user name.
- 2 Select **Options > OK**.
The **Nickname** screen appears with the contact's user name. If you want to enter a nickname by which to identify the contact, select **Clear** as many times as necessary to delete the user name. Then, enter the nickname. This is the name that appears in **IM contacts**.
- 3 Select **Options > OK**.

ADD FROM CONVERSATION MENU

- 1 From the IM online menu, select **Conversations** and the conversation with the contact you want to add.
- 2 Select **Add contact**.
The **User ID** screen appears with the contact's user name.
- 3 Select **Options > OK**.
The **Nickname** screen appears with the contact's user name. If you want to enter a nickname by which to identify the contact, select **Clear** as many times as necessary to delete the user name. Then, enter the nickname. This is the name that appears in **IM contacts**.

Remove

From the IM online menu, select **IM contacts**, the contact you want to remove, and **Remove contact > OK**.

Block

- 1 From the IM online menu, select **IM contacts** and the contact from whom you want to block messages.
- 2 Select **Block contact > OK**.
OR
- 1 During a conversation with a contact, select **Options**.
- 2 Select **Block contact > OK**.

Unblock

- 1 From the IM online menu, select **IM Contacts** and the contact from whom you want to unblock messages.
- 2 Select **Unblock > OK**.
OR
- 1 From the IM online menu, select **Blocked list**.
- 2 Select the contact and **Unblock > OK**.
- 3 To unblock other contacts, repeat step 2.

View blocked list

From the IM online menu, select **Blocked list**.

Alert

SET

You can set an alert for a contact to notify you when the contact's availability changes.

- 1 From the IM online menu, select **IM contacts** and the contact for whom you want to set an alert.
- 2 Select **Set alert**.

REMOVE

- 1 From the IM online menu, select **IM contacts** and the contact for whom you want to remove an alert.
- 2 Select **Remove alert**.

• GROUP CHAT SESSIONS

You can create your own private chat groups from **IM contacts**. See "IM contacts" on page 93.

Create private chat group

From the IM online menu, select **Group convers.**, enter the group name (up to 10 characters), and select **Options > OK > Options > OK**.

Members

ADD

- 1 Select **Options > Group members > Send**.
- 2 Select the contact whom you want to invite to the group chat.
- 3 Enter the invitation text and select **Options > Send**.
- 4 To add other members to the group, repeat steps 2–3.

REMOVE

- 1 From the group list, select the member you want to remove.
- 2 Select **Options > Remove member**.

Invitations

When you receive an invitation to a group chat, the **New invitation received** screen appears, with the user name of the invitation sender and the group name displaying. You can either accept or reject the invitation.

Select **Accept > Options > OK** or select **Reject**.

• IM SETTINGS

You can customize your IM settings, depending upon the IM service you have selected. Select **Settings** from either the IM online or offline menu and the following options appear:

Screen name—Allows you to change your screen name (nickname).

Automatic login—Allows you to set your login to the automatic state.

Sort contacts—Allows you to display your contacts' order either **Alphabetically** or **By status**.

Status updates—Allows you to update your contacts' online availability (presence).

Network—Allows you to view your **User ID**.

Screen name

You can enter a screen name (nickname) that is 1–20 characters in length.

- 1 From either the IM online or offline menu, select **Settings > Screen name**.
- 2 Enter your screen name and select **Options > OK**.

Automatic login

You can use automatic login after you have logged in with your user name and password.

From either the IM online or offline menu, select **Settings > Automatic login > Automatic login on**.

Sort contacts

From either the IM online or offline menu, select **Settings > Sort contacts > Alphabetically or By status**.

Set up presence status updates

Presence allows you and other users to know who is online and available to chat. You can set your phone to automatically update a contact's presence status every time it is changed.

From either the IM online or offline menu, select **Settings > Status updates > On**.

• LOG OFF SERVICE

From the IM online menu, you can exit the IM application, but still stay connected to the IM service. This enables you to receive instant messages from your contacts, when using your phone for other purposes; for example, if you are playing a game. If you are connected to your IM service, but you have not used your IM application for some time, you may be automatically disconnected from the IM service. The next time you open the IM application, you will receive a message, **Not connected** and you will be taken to the offline menu to log in again.

To disconnect from the IM service, you must log out from the IM online menu. You will be taken to the IM offline menu to log in again or exit the IM application.

Exit

From the IM online menu, select **Exit**. If you open **IM** again, you do not need to log in again.

Log out

From the IM online menu, select **Logout > OK** and the IM offline menu appears. If you want to exit **IM**, select **Exit**.

17 Your personal digital assistant

Your Nokia 3595 mobile phone has many useful features for organizing your everyday life, including a calendar, alarm clock, calculator, to-do list, and stopwatch. In this chapter, you'll learn how to use your phone as a personal digital assistant.

• CALENDAR

The calendar shows a month view and day view. You can use the calendar to keep track of reminders, calls you need to make, and birthdays. You can also set an alarm for calendar notes.

View

To view today's date in the calendar, select **Menu > Organizer > Calendar**.

The first time you access the calendar, your phone prompts you to enter the time and today's date.

Navigate

When you open the calendar, the month view shows today's date highlighted. To move the cursor to a new date:

- Press the **2** key to scroll up one week.
- Press the **4** key to scroll left.
- Press the **6** key to scroll right.
- Press the **8** key to scroll down one week.

Make a note

When you make a note in your calendar, you can choose from the following four types:



Reminder



Call



Birthday



Meeting

REMINDER

- 1 Select **Menu > Organizer > Calendar > Options > Make a note > Reminder.**
- 2 Enter your note and select **Options > Save.**
- 3 Select **Alarm on**, enter a time, and select **OK > am or pm.**
OR
Select **Alarm off.**

CALL

- 1 Select **Menu > Organizer > Calendar > Options > Make a note > Call.**
- 2 Enter the phone number and select **Options > Save.**
- 3 Enter the person's name and select **Options > Save.**
- 4 Enter a time, select **OK > am or pm**, and one of the following options:
No alarm
Silent
With tone

If you select **Silent** or **With tone**, you can then select a time.

BIRTHDAY

- 1 Select **Menu > Organizer > Calendar > Options > Make a note > Birthday.**
- 2 Enter the person's name and select **Options > Save.**
- 3 Enter the person's year of birth, select **OK**, and one of the following options:
No alarm
Silent
With tone

If you select **Silent** or **With tone**, you can then select a day and time.

MEETING

- 1 Select **Menu > Organizer > Calendar > Options > Make a note > Meeting.**
- 2 Enter the subject of the meeting and select **Options > Save.**
- 3 Enter the meeting location and select **Options > Save.**
- 4 Enter the meeting start time, select **OK > am or pm**, enter the meeting end time, and select **OK > am or pm** and one of the following options:
No alarm
Silent
With tone

If you select **Silent** or **With tone**, you can then select a time.

View notes

After you make a few calendar notes, you can view the day's events.

- 1 Select **Menu** > **Organizer** > **Calendar** and the date you want.
- 2 Select **Options** > **View day**.

• ALARM CLOCK

The alarm clock feature is based on the phone internal clock and sounds an alert at a time you specify. The alarm clock works even if you turn your phone off.

Set

- 1 Select **Menu** > **Organizer** > **Alarm clock**, enter the alarm time in **hhmm** format, and select **OK**.
- 2 If you have selected the **am/pm** format, select either **am** or **pm**.

Alarm

PHONE ON

Select **Stop** to shut off the alarm.

OR

Select **Snooze**.

The alarm stops and sounds again in ten minutes. If you let the alarm sound for one minute without pressing a key, it stops for ten minutes, and then sounds again.

PHONE OFF

If the alarm time is reached while the device is switched off, the device switches itself on and starts sounding the alarm tone. If you select **Stop**, the device asks whether you want to activate the device for calls. Select **No** to switch off the device or **Yes** to make and receive calls. Do not select **Yes** when wireless phone use may cause interference or danger.

Turn off

Select **Menu** > **Organizer** > **Alarm clock** > **Off**.

• BUSINESS CARDS

Your phone can send or receive an electronic business card as a short text message. The business card can have either:

- A name and number or
- A name, multiple numbers (home, work, fax, mobile), an e-mail address, web address and street address if you have entered this information in **Contacts**.

If you are exchanging business cards with multiple numbers and addresses, both the receiving and sending phone must have a contact list that supports these kinds of entries.

Send

- 1 At the start screen, press the **Up scroll** or **Down scroll** key to scroll to the name to whom you want to send a business card.
- 2 Select **Details > Options > Send bus. card > Via text msg..**
- 3 If the name in **Contacts** has multiple numbers, select one of the following options:
 - Primary number**—Allows you to send a name and number only.
 - All details**—Allows you to send a name, multiple numbers, e-mail, web, and street address.
- 4 Enter the number for the receiving phone and select **OK**.

Receive

Your phone can accept and receive an electronic business card from a compatible phone, if it is one of the following types:

- Nokia Smart Messaging compact business card
- V-card format

If you press the **End** key at any time before saving the business card, the business card will be deleted.

- 1 When your phone displays **Business card received**, select **Show**.
- 2 After viewing the business card, select **Options** and one of the following options:
 - Save**—Allows you to keep the information in **Contacts**.
 - Discard**—Allows you to delete the business card.

• CALCULATOR

The phone calculator adds, subtracts, multiplies, divides, and computes square and square root functions. You can also use the calculator to convert currency.



Note: This calculator has limited accuracy and is designed for simple calculations.

Basic calculations

- 1 Select **Menu** > **Extras** > **Calculator** and enter the first number in the calculation.



Note: Press the **#** key to enter a decimal point and select **Clear** to delete any errors. To add (+), press the ***** key once; to subtract (-), press the ***** key twice; to multiply (*), press the ***** key three times; and to divide (/), press the ***** key four times. To perform a square or square root calculation, select **Options** > **Square** or **Square root**.

- 2 Enter the second number in the calculation and select **Options** > **Equals**.

Convert currency



Note: When you change base currency, you must enter the new rates because all previously set exchange rates are reset to zero.

SET THE EXCHANGE RATE

- 1 Select **Menu** > **Extras** > **Calculator** > **Options** > **Exchange rate** > **Foreign units converted to home units** or **Home units converted to foreign units**.
- 2 Enter the exchange rate and select **OK**.

The exchange rate remains in the phone memory until you replace it.

CONVERT A CURRENCY AMOUNT

- 1 Select **Menu** > **Extras** > **Calculator** and enter the amount to be converted.
- 2 Select **Options** and one of the following options:
 - To home**—Allows you to convert to domestic units.
 - To foreign**—Allows you convert to foreign units.

• TO-DO LIST

You can keep track of your tasks with the to-do list feature. You may be able to save up to 30 notes, depending on how long the notes are.

Add a to-do note

When you add a new note, the default priority is **Medium (2)**. You can change the priority to **High (1)** or **Low (3)**.

- 1 Select **Menu** > **Organizer** > **To-do list** > **Options** > **Add**.
- 2 Enter your note, select **Options** > **Save**, and the priority you want.

Use predictive text

When entering your to-do note, you can use the built-in dictionary to speed things up. See "Text entry" on page 26.

- 1 When entering your note, select **Options > Predictive text**.
- 2 Select the language you want and continue entering your note.

• STOPWATCH

Your phone has a stopwatch that can be used to track time at sporting events or other occasions. The stopwatch displays time in hours, minutes, seconds and fractions of a second.

Time

- 1 Select **Menu > Extras > Stopwatch > Split timing > Start**.
- 2 Select **Stop** to end the timer.

Split time

You can use the split time function for such things as a long distance race when you need to pace yourself.

- 1 Select **Menu > Extras > Stopwatch > Split timing > Start > Split**.
The timer continues to run. The split time appears below the running time.
- 2 Select **Stop** to end the split timer.

If you split the time more than once, the new measured time appears at the beginning of the list. You can scroll to see previous measured times.

Lap time

You can use the lap time function when you want to track how long it takes to complete each cycle or lap.

- 1 Select **Menu > Extras > Stopwatch > Lap timing > Start**.
- 2 If you want to take a lap time, select **Lap**.

The clock stops, then starts immediately from zero. The lap time appears below the running time. If you take more than one lap time, the new measured time appears at the beginning of the list. You can scroll to see previous measured times.

- 3 Select **Stop** to end the lap timer and to display the total time at the top of the screen.

Save times

- 1 While the timer is running, select **Stop > Options > Save**.
- 2 Enter a name for the measurement and select **OK**.
If you do not enter a name, the total time is used as the default title for the lap time.

View times

You can view saved times, which are listed in the order they were saved.

Select **Menu > Extras > Stopwatch > View times** and the time you want to view.

Delete times

You can delete times from the stop watch memory. You can delete times one at a time or delete all the times at once.

ALL

Select **Menu > Extras > Stopwatch > Delete times > Delete all > OK**.

ONE BY ONE

- 1 Select **Menu > Extras > Stopwatch > Delete times > One by one**.
- 2 Select the time you want to delete and **Delete > OK**.
OR
- 1 Select **Menu > Extras > Stopwatch > View times**.
- 2 Select the time you want to delete and **Options > Delete times > OK**.

Stopwatch options

You can select the following options when using the stopwatch:

Start—Allows you to start timing again after the timing has stopped. If the maximum amount of laps has been saved, this option is not available.

Save—Allows you to save and name the last measured time. If the stopwatch memory is full, you will be prompted to delete saved times.

Reset—Allows you to reset the stopwatch.

Note about stopwatch operation

Using the stopwatch or allowing it to run in the background when using other features increases the demand on battery power and reduces the battery life.

If you press the **End** key and return to the start screen, the clock continues to run in the background.

To return to the **Stopwatch** function, select **Menu > Extras > Stopwatch > Continue**.

• SYNCHRONIZE CONTACTS AND CALENDAR

Your phone has the ability to synchronize the **Contacts** and **Calendar** data with remote devices. Using the synchronization feature (SyncML), data such as names, numbers, and e-mail addresses stored in your contact list, or day notes and reminders from the calendar can be exchanged with other devices through a synchronization service provider. After synchronization, the data in the phone will be the same as the data contained in the host database.

Before you begin

Before you can begin to use SyncML, you must verify your service provider offers this feature. If your service provider does offer SyncML, you must set up an account with a SyncML service provider. For more information about signing up for synchronization services, contact your wireless service provider.

Automatic configuration

Your wireless service provider can automatically configure your phone with the correct synchronization settings by using SMS. This can only take place while your phone is in idle mode. Contact your service provider for more information.

Even though it is highly recommended that your service provider configure the correct synchronization settings for you, it is helpful for you to know the meaning of the settings. To view the synchronization settings, select **Menu > Connectivity > Synchronize > Settings > Active Internet sync. settings** or **Custom. active Internet sync.** and one of the following options:

Active Internet sync. settings—Allows you to select which synchronization set to activate. You have the option of renaming the set. There are four sets available.

Custom. active Internet sync. settings—Allows you to customize the active synchronization set from a set of options, which are shown in the following table:

Choice	What it does
Settings' name	Allows the synchronization set to be renamed.
Data to be synchronized	Allows the selection of the databases to be synchronized. When this setting is selected, there are two options available, Contacts or Calendar , which will be implemented during future synchronization sessions.
Database addresses	Allows the database address to be entered for the databases that are to be synchronized.

Choice	What it does
User name	Allows creation or change of a user name for authorization with the synchronization server. If a user name has been previously entered, it appears.
Password	Allows a password to be established or changed, which is used to authenticate the user name while connecting with the synchronization server. If the password or user name is changed in the phone without also changing them with the synchronization service provider, the data will not be able to be synchronized.
Synchronization Server	Allows the input of the name of the synchronization server used to synchronize the data.

Start

During the synchronization process, it is not possible to access the database where your data is stored. However, you can cancel the synchronization process by selecting **Quit** or pressing the **End** key. It is not possible to place or receive calls, including emergency calls, during synchronization. To place a call, you must cancel the synchronization process.

- 1 Select **Menu > Connectivity > Synchronize > Synchronize > Yes**.
Once all selected databases have been synchronized, a confirmation note appears, indicating which databases have been synchronized.
- 2 When the process is complete, select **OK** to return to the start screen.

18 Fun and games

• GAMES

Challenge yourself or a friend to one of the four fun games in your phone.

- In **Air Glide**, you try to land the glider in the zone. You must avoid running into birds because they will destroy the glider.
- In **Bowling**, you try to score as many points as possible. Hit strikes and spares as you go for glory and monitor your progress on the high score chart.
- In **Sky Diver**, your goal is to score as many points as you can by skydiving through target rings and parachuting into the landing area of the jump zone.
- In **Backgammon**, you can play one of the world's most popular and enduring games. Use a doubling cube which allows you to successively double the points at stake over a game while you play.

Start

- 1 Select **Menu > Games > Select game** and the game you want.
- 2 Select **Options > Open > New game**.

Adjust settings

Select **Menu > Games > Settings** and one of the following options:

Game sounds—Used to turn game sound effects **On** or **Off**.

Game lights—Used to turn screen lights **On** or **Off** during game play only.

Shakes—Used to turn game vibrating effects **On** or **Off**.

Control

AIR GLIDE

Press the **4** key to move the glider to the left and press the **6** key to move it to the right. You can select the level of play to be either easy or difficult.

- 1 Select **Menu > Games > Select game > Air Glide > Options > Open**.
- 2 Select **Game level > Easy or Difficult**.

BOWLING

Press the **4** key to move the ball to the left and press the **6** key to move the ball to the right. Press the **5** key to select the speed and spin of the ball and to roll the ball down the lane.

SKY DIVER

The onscreen information for **Sky Diver** shows altitude on the left, wind speed and direction in the center, distance and direction to the landing zone on the right. Fire flares the parachute and slows the skydiver down. Too much flaring will cause the skydiver to stall. The default control keys are, as follows:

The **2** key makes the sky diver lean forward.

The **8** key makes the sky diver lean backward.

The **4** key rotates the sky diver to the **left**.

The **6** key rotates the sky diver to the **right**.

The **5** key fires open the parachute.

You can redefine the controls by selecting the keys you want.

- 1 Select **Menu > Games > Select game > Sky Diver > Options > Open > Options > Controls > Define keys**.
- 2 Select each key to which you want to assign the up, down, left, right, and fire controls.



Note: You cannot exit this option until you have define all five controls.

BACKGAMMON

You can select and move bricks according to die throws. Black bricks are moved clockwise, white bricks counter-clockwise. You can move the cursor by pressing the **4** and **6** keys, but it can only be moved to valid points. Press the **5** key to select and deselect bricks. Press the **0** key to zoom in on dice. During game play, press the **Left selection** key to access a menu for doubling and statistics. Press the **Right selection** key to end the game.

Delete

You can delete games from the phone memory to free more memory.



Important: Once you delete a game from the game downloads, you cannot download it back into the **Games** menu. You can only download it into the **Applications** menu.

- 1 Select **Menu > Games > Select game**.
- 2 Select the game you want and **Options > Delete > OK**.

Downloads

You can connect to game downloads on the mobile Internet by using your WAP browser, if this service is available from your service provider. Check with your service provider for availability and details for use.

Select **Menu > Games > Game downloads**, and the bookmark you want to launch.

If the game you download has not been approved by Nokia, it will likely be downloaded to the **Applications** menu. Generally, games accessed through the **Games** menu were either preloaded on your phone or downloaded from a website containing games approved by Nokia.

• JAVA™ APPLICATIONS

Your Nokia 3595 mobile phone has an **Applications** menu for downloading and storing Java applications or midlets. Your phone may come preloaded with midlets specially designed for your phone.

Examples of downloadable Java applications include interactive games, animations, sports training calendars, and map applications.

Launch an application

- 1 Select **Menu > Applications > Select app.** and the application you want to launch.
- 2 Select **Options > Open.**

If an application uses the whole display area, no selection key names are displayed. Press one of the selection keys to show the options list. Then, select one of the options or select **Back** to continue with the application.

Check available memory

Before you download new applications to your Nokia 3595 mobile phone, be sure to check the available memory.

- 1 Select **Menu > Applications > Memory.**
- 2 Press the **Down scroll** key to display how the memory is being used between phone applications and games.
- 3 Select **Back** to return to the menu.

Download an application

You can download new Java applications from the mobile Internet. Use the WAP browser to find an appropriate application.



Important: Only install applications from sources that offer adequate protection against harmful software.

- 1 Select **Menu > Applications > App. downloads.**
- 2 If applicable, select **More bookmarks** and the bookmark that contains the application you want to download.

See “Connect” on page 83 for more information about connecting to the WAP browser.

Choose other application options

When viewing the list of applications, select **Options** to access the following choices:

Open—Allows you to launch an application.

Delete—Allows you to delete the application or application set from the phone.

Web access—An application may require web access to make updates. You can restrict the application from accessing the mobile Internet. Your choices include **Ask first**, **Allowed**, and **Not allowed**.

Update version—Allows you to check if a new version of the application is available for download from mobile Internet services.

Web page—Allows you to check on additional information for the application from Internet Mobile Services. **Web page** is shown only if an Internet address has been provided with the application.

Serv. settings—Allows you to select specific service settings for certain applications. Your phone is set to use the default service settings for the browser.

Details—Allows you to view information about the application, for example, the name, version number, vendor, a brief description, or memory size.

• CONVERTER

This application converts many common unit types. Switch the conversion direction with the **Up scroll** key and the **Down scroll** key. Press the ***** key for the minus (-) sign and press the **#** key for the decimal point.

1 Select **Menu > Applications > Select app. > Converter > Options > Open.**

2 Select **Options** to display the following options:

Clear all—Reset the application.

Reverse conv.—Toggle the unit conversion direction.

Set conversion—Set a unit conversion to a certain state that always occurs when you enter the application. The unit types that are available for conversion are:

- **Temperature**
- **Currency**
- **Weight**
- **Length**
- **Area**
- **Volume**

Modify—Add new conversions or adjust exchange rates.

Instructions—Display instructions for use.

Change sign—Toggle the value of the unit from positive (+) to negative (-) and vice versa.

19 Enhancements

If you want to enhance phone functionality, a range of enhancements is available for you. You can select any of these items to help accommodate your specific communication needs. For availability of these and other enhancements, contact your dealer. Stylish carrying cases that protect your Nokia 3595 mobile phone are available for purchase and can be located at www.nokiausa.com.



• POWER

- 1000-mAh Li-Ion Battery (BLC-2)
- Standard Travel Charger (ACP-7)
- Travel Charger (ACP-12)
- Compact Desktop Charging Stand (DCV-10)
- Battery Charging Stand (DDC-1)

• AUDIO

- Headset (HDC-5)
- Headset (HDE-2)
- Boom Headset (HDB-5)
- Retractable Headset (HDC-10)
- Mobile Inductive Loopset (LPS-3)
- Phone Adapter (HDA-9)

• CAR

- Mobile Holder (MBC-15S)
- Headrest Handsfree (BHF-1)
- Express Car Kit (CARK-125)
- Full Car Kit (CARK-134)
- Mobile Charger (LCH-9)
- Mobile Charger (LCH-12)

20 Reference information

• BATTERY INFORMATION

Charging and discharging

Your device is powered by a rechargeable battery. The full performance of a new battery is achieved only after two or three complete charge and discharge cycles. The battery can be charged and discharged hundreds of times but it will eventually wear out. When the talk and standby times are noticeably shorter than normal, buy a new battery. Use only Nokia approved batteries, and recharge your battery only with Nokia approved chargers designated for this device.

Unplug the charger from the electrical plug and the device when not in use. Do not leave the battery connected to a charger. Overcharging may shorten its lifetime. If left unused, a fully charged battery will lose its charge over time. Temperature extremes can affect the ability of your battery to charge.

Use the battery only for its intended purpose. Never use any charger or battery that is damaged.

Do not short-circuit the battery. Accidental short-circuiting can occur when a metallic object such as a coin, clip, or pen causes direct connection of the positive (+) and negative (-) terminals of the battery. (These look like metal strips on the battery.) This might happen, for example, when you carry a spare battery in your pocket or purse. Short-circuiting the terminals may damage the battery or the connecting object.

Leaving the battery in hot or cold places, such as in a closed car in summer or winter conditions, will reduce the capacity and lifetime of the battery. Always try to keep the battery between 59°F and 77°F (15°C and 25°C). A device with a hot or cold battery may not work temporarily, even when the battery is fully charged. Battery performance is particularly limited in temperatures well below freezing.

Do not dispose of batteries in a fire! Dispose of batteries according to local regulations. Please recycle when possible. Do not dispose as household waste.

• ENHANCEMENTS

A few practical rules about accessories and enhancements:

- Keep all accessories and enhancements out of the reach of small children.
- When you disconnect the power cord of any accessory or enhancement, grasp and pull the plug, not the cord.
- Check regularly that enhancements installed in a vehicle are mounted and are operating properly.
- Installation of any complex car enhancements must be made by qualified personnel only.

• ENHANCEMENTS, BATTERIES, AND CHARGERS

Check the model number of any charger before use with this device. This device is intended for use when supplied with power from the standard travel charger (ACP-7).



Warning: Use only batteries, chargers, and enhancements approved by Nokia for use with this particular model. The use of any other types may invalidate any approval or warranty, and may be dangerous.

For availability of approved enhancements, please check with your dealer. When you disconnect the power cord of any enhancement, grasp and pull the plug, not the cord.

Your device and its enhancements may contain small parts. Keep them out of reach of small children.

• CARE AND MAINTENANCE

Your device is a product of superior design and craftsmanship and should be treated with care. The suggestions below will help you protect your warranty coverage and enjoy your device for many years.

- Keep the device dry. Precipitation, humidity, and all types of liquids or moisture can contain minerals that will corrode electronic circuits. If your device does get wet, remove the battery and allow the device to dry completely before replacing it.
- Do not use or store the device in dusty, dirty areas. Its moving parts and electronic components can be damaged.
- Do not store the device in hot areas. High temperatures can shorten the life of electronic devices, damage batteries, and warp or melt certain plastics.
- Do not store the device in cold areas. When the device returns to its normal temperature, moisture can form inside the device and damage electronic circuit boards.
- Do not attempt to open the device other than as instructed in this guide.
- Do not drop, knock, or shake the device. Rough handling can break internal circuit boards and fine mechanics.
- Do not use harsh chemicals, cleaning solvents, or strong detergents to clean the device.
- Do not paint the device. Paint can clog the moving parts and prevent proper operation.
- Use only the supplied or an approved replacement antenna. Unauthorized antennas, modifications, or attachments could damage the device and may violate regulations governing radio devices.

All of the above suggestions apply equally to your device, battery, charger, or any enhancement. If any device is not working properly, take it to the nearest authorized service facility for service.

• ADDITIONAL SAFETY INFORMATION

Operating environment

Remember to follow any special regulations in force in any area and always switch off your device when its use is prohibited or when it may cause interference or danger. Use the device only in its normal operating positions. To maintain compliance with radio frequency exposure guidelines only use accessories approved by Nokia for use with this device. When the device is on and being worn on the body, always use an approved carrying case.

Medical devices

Operation of any radio transmitting equipment, including wireless phones, may interfere with the functionality of inadequately protected medical devices. Consult a physician or the manufacturer of the medical device to determine if they are adequately shielded from external RF energy or if you have any questions. Switch off your phone in health care facilities when any regulations posted in these areas instruct you to do so. Hospitals or health care facilities may be using equipment that could be sensitive to external RF energy.

PACEMAKERS

Pacemaker manufacturers recommend that a minimum separation of 6 in (15.3 cm) be maintained between a wireless phone and a pacemaker to avoid potential interference with the pacemaker. These recommendations are consistent with the independent research by and recommendations of Wireless Technology Research. To minimize the potential for interference, persons with pacemakers should

- Always keep the device more than 6 in (15.3 cm) from their pacemaker when the device is switched on
- Not carry the device in a breast pocket
- Hold the device to the ear opposite the pacemaker

If you have any reason to suspect that interference is taking place, switch off your device immediately.

HEARING AID

Some digital wireless devices may interfere with some hearing aids. If interference occurs, consult your service provider.

Vehicles

RF signals may affect improperly installed or inadequately shielded electronic systems in motor vehicles such as electronic fuel injection systems, electronic antiskid (antilock) braking systems, electronic speed control systems, air bag systems. For more information, check with the manufacturer or its representative of your vehicle or any equipment that has been added.

Only qualified personnel should service the device, or install the device in a vehicle. Faulty installation or service may be dangerous and may invalidate any warranty that may apply to the device. Check regularly that all wireless device equipment in your vehicle is mounted and operating properly. Do not store or carry flammable liquids, gases, or explosive materials in the same compartment as the device, its parts, or enhancements. For vehicles equipped with an air bag, remember that an air bags inflate with great force. Do not place objects, including installed or portable wireless equipment in the area over the air bag or in the air bag deployment area. If in-vehicle wireless equipment is improperly installed and the air bag inflates, serious injury could result.

Potentially explosive environments

Switch off your device when in any area with a potentially explosive atmosphere and obey all signs and instructions. Potentially explosive atmospheres include areas where you would normally be advised to turn off your vehicle engine. Sparks in such areas could cause an explosion or fire resulting in bodily injury or even death. Switch off the device at refuelling points such as near gas pumps at service stations. Observe restrictions on the use of radio equipment in fuel depots, storage, and distribution areas, chemical plants or where blasting operations are in progress. Areas with a potentially explosive atmosphere are often but not always clearly marked. They include below deck on boats, chemical transfer or storage facilities, vehicles using liquefied petroleum gas (such as propane or butane), and areas where the air contains chemicals or particles such as grain, dust or metal powders.

FCC regulations prohibit using your wireless device while in the air. The use of wireless telephones in an aircraft may be dangerous to the operation of the aircraft, disrupt the wireless telephone network, and may be illegal.

Failure to observe these instructions may lead to suspension or denial of telephone services to the offender, legal action, or both.

EMERGENCY CALLS



Important: Wireless phones, including this phone, operate using radio signals, wireless networks, landline networks, and user-programmed functions. Because of this, connections in all conditions cannot be guaranteed. You should never rely solely on any wireless phone for essential communications like medical emergencies.

To make an emergency call:

- 1 If the phone is not on, switch it on. Check for adequate signal strength. Some networks may require that a valid SIM card is properly inserted in the phone.
- 2 Press the **End** key as many times as needed to clear the display and ready the phone for calls.
- 3 Key in the official emergency number for your present location. Emergency numbers vary by location.
- 4 Press the **Talk** key.

If certain features are in use, you may first need to turn those features off before you can make an emergency call. Consult this guide or your service provider. When making an emergency call, give all the necessary information as accurately as possible. Your wireless phone may be the only means of communication at the scene of an accident. Do not end the call until given permission to do so.

Certification Information (SAR)

THIS MODEL PHONE MEETS THE GOVERNMENT'S REQUIREMENTS FOR EXPOSURE TO RADIO WAVES.

Your wireless phone is a radio transmitter and receiver. It is designed and manufactured not to exceed the emission limits for exposure to radio frequency (RF) energy set by the Federal Communications Commission of the U.S. Government. These limits are part of comprehensive guidelines and establish permitted levels of RF energy for the general population. The guidelines are based on standards that were developed by independent scientific organizations through periodic and thorough evaluation of scientific studies. The standards include a substantial safety margin designed to assure the safety of all persons, regardless of age and health.

The exposure standard for wireless mobile phones employs a unit of measurement known as the Specific Absorption Rate, or SAR. The SAR limit set by the FCC is 1.6W/kg.* Tests for SAR are conducted using standard operating positions accepted by the FCC with the phone transmitting at its highest certified power level in all tested frequency bands. Although the SAR is determined at the highest certified power level, the actual SAR level of the phone while operating can be well below the maximum value. This is because the phone is designed to operate at multiple power levels so as to use only the power required to reach the network. In general, the closer you are to a wireless base station antenna, the lower the power output.

Before a phone model is available for sale to the public, it must be tested and certified to the FCC that it does not exceed the limit established by the government-adopted requirement for safe exposure. The tests are performed in positions and locations (for example, at the ear and worn on the body) as required by the FCC for each model.

The highest SAR value for this model phone as reported to the FCC:

When tested for use at the ear -

FCCID # GMLNPM-10 is 1.08 W/kg

FCCID # GMLNPM-10X is 1.19W/kg

When worn on the body, as described in this user guide:

FCCID # GMLNPM-10 is 0.73 W/kg

FCCID # GMLNPM-10X is 0.90 W/kg

(Body-worn measurements differ among phone models, depending upon available accessories and FCC requirements).

While there may be differences between the SAR levels of various phones and at various positions, they all meet the government requirement.

The FCC has granted an Equipment Authorization for this model phone with all reported SAR levels evaluated as in compliance with the FCC RF exposure guidelines. SAR information on this model phone is on file with the FCC and can be found under the Display Grant section of <http://www.fcc.gov/oet/fccid> after searching on FCC ID GMLNPM-10 and GMLNPM-10X. For body worn operation, this phone has been tested and meets the FCC RF exposure guidelines for use with an accessory that contains no metal and that positions the handset a minimum of 5/8 inch (1.5 cm) from the body. Use of other accessories may not ensure compliance with FCC RF exposure guidelines. If you do not use a body-worn accessory and are not holding the phone at the ear, position the handset a minimum of 5/8 inch (1.5 cm) from your body when the phone is switched on.

*In the United States and Canada, the SAR limit for mobile phones used by the public is 1.6 watts/kilogram (W/kg) averaged over one gram of tissue. The standard incorporates a substantial margin of safety to give additional protection for the public and to account for any variations in measurements. SAR values may vary depending on national reporting requirements and the network band. For SAR information in other regions please look under product information at www.nokia.com/us.

• BATTERIES

This section provides information about the battery in the phone. Be aware that the information in this section is subject to change.



Note: The phone uses a lithium ion (Li-Ion) battery. Dispose of used batteries in accordance with any local regulations. Do not dispose of as household waste.

The tables shown in this section provide information about the batteries that are available for your phone, charging times with the standard travel charger (ACP-7), talk times, and standby times. Consult your service provider for more information.

Charging times

The charging times listed below are approximate.

Battery option	ACP-7 Charger
BLC-2 Li-Ion Battery 1000 mAh	3.5 h

Standby and talk times

The times shown in the following table are estimates only and represent a range for either standby or talk times (not a combination of both). The operation time of the battery depends on conditions such as:

- Transmitting power level
- Signal (distance between the phone and the base station)
- Network parameters defined by the operator
- Phone use (WAP, games, SMS)
- Charging procedure used

Battery option	Talk time	Standby time
BLC-2 Li-Ion Battery 1000 mAh	up to 5.5 h	up to 10 d

21 Technical information

Feature	Specification
Weight	107 g with BLC-2 1000 mAh battery
Size	Length 119 mm (4.68 in) Width 50 mm (1.97 in) Depth 23 mm (0.90 in)
Frequency Range	GSM 850 824.2 to 848.8 MHz (TX) 869.2 to 893.8 MHz (RX) GSM 1900 1850.2 to 1909.8 MHz (TX) 1930.2 to 1989.8 MHz (RX)
Transmitter Output Power	GSM 850 2 W GSM 1900 1 W
Battery Voltage	3.6 V dc nominal 3.6 V dc for car kit
Operating Temperature	14° F to + 131° F (-10° C to + 55° C)
Networks	GSM 850 MHz/1900 MHz
Contacts	Up to 500 contacts in the phone. Each contact holds up to 5 numbers and 3 text fields (dynamic memory). Check with your SIM card provider or carrier for information about SIM card memory capacity.

22 Troubleshooting

This section provides a table that lists some of the most commonly encountered problems and provides possible causes and solutions.

Problem	Possible cause	Possible solution
My phone is not charging.	The charger and the phone are not properly connected.	Securely connect the charger to the phone.
	The charger is not properly plugged in.	Make sure that the charger is plugged in correctly.
My phone is not making/answering calls.	The battery is not charged.	Charge the battery.
	The signal strength is poor.	If you are indoors, move toward a window.
I cannot listen to my voice messages.	You do not have voice mail service.	Call your wireless service provider.
	You have not set up your voice mailbox with your service provider.	Call your wireless service provider.
	You have not saved your voice mail number in your phone.	Refer to "Voice features" on page 45.
	The voice mail number you have saved is incorrect.	Call your wireless service provider.
	You have forgotten your password or are entering it incorrectly.	Call your wireless service provider.

23 Nokia One-Year Limited Warranty

Nokia Inc. ("Nokia") warrants that this cellular phone ("Product") is free from defects in material and workmanship that result in Product failure during normal usage, according to the following terms and conditions:

- 1 The limited warranty for the Product extends for ONE (1) year beginning on the date of the purchase of the Product. This one year period is extended by each whole day that the Product is out of your possession for repair under this warranty.
- 2 The limited warranty extends only to the original purchaser ("Consumer") of the Product and is not assignable or transferable to any subsequent purchaser/end-user.
- 3 The limited warranty extends only to Consumers who purchase the Product in the United States of America.
- 4 During the limited warranty period, Nokia will repair, or replace, at Nokia's sole option, any defective parts, or any parts that will not properly operate for their intended use with new or refurbished replacement items if such repair or replacement is needed because of product malfunction or failure during normal usage. No charge will be made to the Consumer for any such parts. Nokia will also pay for the labor charges incurred by Nokia in repairing or replacing the defective parts. The limited warranty does not cover defects in appearance, cosmetic, decorative or structural items, including framing, and any non-operative parts. Nokia's limit of liability under the limited warranty shall be the actual cash value of the Product at the time the Consumer returns the Product for repair, determined by the price paid by the Consumer for the Product less a reasonable amount for usage. Nokia shall not be liable for any other losses or damages. These remedies are the Consumer's exclusive remedies for breach of warranty.
- 5 Upon request from Nokia, the Consumer must prove the date of the original purchase of the Product by a dated bill of sale or dated itemized receipt.
- 6 The Consumer shall bear the cost of shipping the Product to Nokia in Melbourne, Florida. Nokia shall bear the cost of shipping the Product back to the Consumer after the completion of service under this limited warranty.
- 7 The Consumer shall have no coverage or benefits under this limited warranty if any of the following conditions are applicable:
 - a) The Product has been subjected to abnormal use, abnormal conditions, improper storage, exposure to moisture or dampness, unauthorized modifications, unauthorized connections, unauthorized repair, misuse, neglect, abuse, accident, alteration, improper installation, or other acts which are not the fault of Nokia, including damage caused by shipping.

- b) The Product has been damaged from external causes such as collision with an object, or from fire, flooding, sand, dirt, windstorm, lightning, earthquake or damage from exposure to weather conditions, an Act of God, or battery leakage, theft, blown fuse, or improper use of any electrical source, damage caused by computer or internet viruses, bugs, worms, Trojan Horses, cancelbots or damage caused by the connection to other products not recommended for interconnection by Nokia.
 - c) Nokia was not advised in writing by the Consumer of the alleged defect or malfunction of the Product within fourteen (14) days after the expiration of the applicable limited warranty period.
 - d) The Product serial number plate or the enhancement data code has been removed, defaced or altered.
 - e) The defect or damage was caused by the defective function of the cellular system or by inadequate signal reception by the external antenna, or viruses or other software problems introduced into the Product.
- 8** Nokia does not warrant uninterrupted or error-free operation of the Product. If a problem develops during the limited warranty period, the Consumer shall take the following step-by-step procedure:
- a) The Consumer shall return the Product to the place of purchase for repair or replacement processing.
 - b) If "a" is not convenient because of distance (more than 50 miles) or for other good cause, the Consumer shall ship the Product prepaid and insured to:
Nokia Inc., Attn: Repair Department
795 West Nasa Blvd.
Melbourne, FL 32901
 - c) The Consumer shall include a return address, daytime phone number and/ or fax number, complete description of the problem, proof of purchase and service agreement (if applicable). Expenses related to removing the Product from an installation are not covered under this limited warranty.
 - d) The Consumer will be billed for any parts or labor charges not covered by this limited warranty. The Consumer will be responsible for any expenses related to reinstallation of the Product.
 - e) Nokia will repair the Product under the limited warranty within 30 days after receipt of the Product. If Nokia cannot perform repairs covered under this limited warranty within 30 days, or after a reasonable number of attempts to repair the same defect, Nokia at its option, will provide a replacement Product or refund the purchase price of the Product less a reasonable amount for usage. In some states the Consumer may have the right to a loaner if the repair of the Product takes more than ten (10) days. Please contact the Customer Service Center at Nokia at the telephone number listed at the end of this warranty if you need a loaner and the repair of the Product has taken or is estimated to take more than ten (10) days.

- f) If the Product is returned during the limited warranty period, but the problem with the Product is not covered under the terms and conditions of this limited warranty, the Consumer will be notified and given an estimate of the charges the Consumer must pay to have the Product repaired, with all shipping charges billed to the Consumer. If the estimate is refused, the Product will be returned freight collect. If the Product is returned after the expiration of the limited warranty period, Nokia's normal service policies shall apply and the Consumer will be responsible for all shipping charges.
- 9 You (the Consumer) understand that the product may consist of refurbished equipment that contains used components, some of which have been reprocessed. The used components comply with Product performance and reliability specifications.
 - 10 ANY IMPLIED WARRANTY OF MERCHANTABILITY, OR FITNESS FOR A PARTICULAR PURPOSE OR USE, SHALL BE LIMITED TO THE DURATION OF THE FOREGOING LIMITED WRITTEN WARRANTY. OTHERWISE, THE FOREGOING LIMITED WARRANTY IS THE CONSUMER'S SOLE AND EXCLUSIVE REMEDY AND IS IN LIEU OF ALL OTHER WARRANTIES, EXPRESS OR IMPLIED. NOKIA SHALL NOT BE LIABLE FOR SPECIAL, INCIDENTAL, PUNITIVE OR CONSEQUENTIAL DAMAGES, INCLUDING BUT NOT LIMITED TO LOSS OF ANTICIPATED BENEFITS OR PROFITS, LOSS OF SAVINGS OR REVENUE, LOSS OF DATA, PUNITIVE DAMAGES, LOSS OF USE OF THE PRODUCT OR ANY ASSOCIATED EQUIPMENT, COST OF CAPITAL, COST OF ANY SUBSTITUTE EQUIPMENT OR FACILITIES, DOWNTIME, THE CLAIMS OF ANY THIRD PARTIES, INCLUDING CUSTOMERS, AND INJURY TO PROPERTY, RESULTING FROM THE PURCHASE OR USE OF THE PRODUCT OR ARISING FROM BREACH OF THE WARRANTY, BREACH OF CONTRACT, NEGLIGENCE, STRICT TORT, OR ANY OTHER LEGAL OR EQUITABLE THEORY, EVEN IF NOKIA KNEW OF THE LIKELIHOOD OF SUCH DAMAGES. NOKIA SHALL NOT BE LIABLE FOR DELAY IN RENDERING SERVICE UNDER THE LIMITED WARRANTY, OR LOSS OF USE DURING THE PERIOD THAT THE PRODUCT IS BEING REPAIRED.
 - 11 Some states do not allow limitation of how long an implied warranty lasts, so the one year warranty limitation may not apply to you (the Consumer). Some states do not allow the exclusion or limitation of incidental and consequential damages, so certain of the above limitations or exclusions may not apply to you (the Consumer). This limited warranty gives the Consumer specific legal rights and the Consumer may also have other rights which vary from state to state.
 - 12 Nokia neither assumes nor authorizes any authorized service center or any other person or entity to assume for it any other obligation or liability beyond that which is expressly provided for in this limited warranty including the provider or seller of any extended warranty or service agreement.

- 13** This is the entire warranty between Nokia and the Consumer, and supersedes all prior and contemporaneous agreements or understandings, oral or written, relating to the Product, and no representation, promise or condition not contained herein shall modify these terms.
- 14** This limited warranty allocates the risk of failure of the Product between the Consumer and Nokia. The allocation is recognized by the Consumer and is reflected in the purchase price.
- 15** Any action or lawsuit for breach of warranty must be commenced within eighteen (18) months following purchase of the Product.
- 16** Questions concerning this limited warranty may be directed to:
Nokia Inc.
Attn: Customer Service
7725 Woodland Center Blvd., Ste. 150
Tampa, FL 33614
Telephone: 1-888-NOKIA-2U (1-888-665-4228)
Facsimile: (813) 287-6612
TTY/TDD Users Only: 1-800-24-NOKIA (1-800-246-6542)
- 17** The limited warranty period for Nokia supplied attachments and accessories is specifically defined within their own warranty cards and packaging.

Appendix A

Message from the CTIA (Cellular Telecommunications & Internet Association) to all users of mobile phones

© 2001 Cellular Telecommunications & Internet Association. All Rights Reserved. 1250 Connecticut Avenue, NW Suite 800, Washington, DC 20036.
Phone: (202) 785-0081

Safety is the most important call you will ever make.

A Guide to Safe and Responsible Wireless Phone Use

Tens of millions of people in the U.S. today take advantage of the unique combination of convenience, safety and value delivered by the wireless telephone. Quite simply, the wireless phone gives people the powerful ability to communicate by voice--almost anywhere, anytime--with the boss, with a client, with the kids, with emergency personnel or even with the police. Each year, Americans make billions of calls from their wireless phones, and the numbers are rapidly growing. But an important responsibility accompanies those benefits, one that every wireless phone user must uphold. When driving a car, driving is your first responsibility. A wireless phone can be an invaluable tool, but good judgment must be exercised at all times while driving a motor vehicle--whether on the phone or not.

The basic lessons are ones we all learned as teenagers. Driving requires alertness, caution and courtesy. It requires a heavy dose of basic common sense--keep your head up, keep your eyes on the road, check your mirrors frequently and watch out for other drivers. It requires obeying all traffic signs and signals and staying within the speed limit. It means using seatbelts and requiring other passengers to do the same.

But with wireless phone use, driving safely means a little more. This brochure is a call to wireless phone users everywhere to make safety their first priority when behind the wheel of a car. Wireless telecommunications is keeping us in touch, simplifying our lives, protecting us in emergencies and providing opportunities to help others in need.

When it comes to the use of wireless phones, *safety is your most important call.*

Wireless Phone "Safety Tips"

Below are safety tips to follow while driving and using a wireless phone which should be easy to remember.

- 1 Get to know your wireless phone and its features such as speed dial and redial. Carefully read your instruction manual and learn to take advantage of valuable features most phones offer, including automatic redial and memory. Also, work to memorize the phone keypad so you can use the speed dial function without taking your attention off the road.
- 2 When available, use a hands free device. A number of hands free wireless phone accessories are readily available today. Whether you choose an installed mounted device for your wireless phone or a speaker phone accessory, take advantage of these devices if available to you.
- 3 Position your wireless phone within easy reach. Make sure you place your wireless phone within easy reach and where you can grab it without removing your eyes from the road. If you get an incoming call at an inconvenient time, if possible, let your voice mail answer it for you.
- 4 Suspend conversations during hazardous driving conditions or situations. Let the person you are speaking with know you are driving; if necessary, suspend the call in heavy traffic or hazardous weather conditions. Rain, sleet, snow and ice can be hazardous, but so is heavy traffic. As a driver, your first responsibility is to pay attention to the road.

- 5 Do not take notes or look up phone numbers while driving. If you are reading an address book or business card, or writing a "to do" list while driving a car, you are not watching where you are going. It's common sense. Don't get caught in a dangerous situation because you are reading or writing and not paying attention to the road or nearby vehicles.
- 6 Dial sensibly and assess the traffic; if possible, place calls when you are not moving or before pulling into traffic. Try to plan your calls before you begin your trip or attempt to coincide your calls with times you may be stopped at a stop sign, red light or otherwise stationary. But if you need to dial while driving, follow this simple tip--dial only a few numbers, check the road and your mirrors, then continue.
- 7 Do not engage in stressful or emotional conversations that may be distracting. Stressful or emotional conversations and driving do not mix--they are distracting and even dangerous when you are behind the wheel of a car. Make people you are talking with aware you are driving and if necessary, suspend conversations which have the potential to divert your attention from the road.
- 8 Use your wireless phone to call for help. Your wireless phone is one of the greatest tools you can own to protect yourself and your family in dangerous situations--with your phone at your side, help is only three numbers away. Dial 9-1-1 or other local emergency number in the case of fire, traffic accident, road hazard or medical emergency. Remember, it is a free call on your wireless phone!
- 9 Use your wireless phone to help others in emergencies. Your wireless phone provides you a perfect opportunity to be a "Good Samaritan" in your community. If you see an auto accident, crime in progress or other serious emergency where lives are in danger, call 9-1-1 or other local emergency number, as you would want others to do for you.
- 10 Call roadside assistance or a special wireless non-emergency assistance number when necessary. Certain situations you encounter while driving may require attention, but are not urgent enough to merit a call for emergency services. But you still can use your wireless phone to lend a hand. If you see a broken-down vehicle posing no serious hazard, a broken traffic signal, a minor traffic accident where no one appears injured or a vehicle you know to be stolen, call roadside assistance or other special non-emergency wireless number.

Careless, distracted individuals and people driving irresponsibly represent a hazard to everyone on the road. Since 1984, the Cellular Telecommunications Industry Association and the wireless industry have conducted educational outreach to inform wireless phone users of their responsibilities as safe drivers and good citizens. As we approach a new century, more and more of us will take advantage of the benefits of wireless telephones. And, as we take to the roads, we all have a responsibility to drive safely.

The wireless industry reminds you to use your phone safely when driving.

For more information, please call 1-888-901-SAFE.

For updates: <http://www.wow-com.com/consumer/issues/driving/articles.cfm?ID=85>

NOTES

Appendix B

Message from the FDA (U.S. Food and Drug Administration) to all users of mobile phones

©July 18, 2001 For updates: <http://www.fda.gov/cdrh/phones>

Consumer Update on Wireless Phones

U.S. Food and Drug Administration

1. Do wireless phones pose a health hazard?

The available scientific evidence does not show that any health problems are associated with using wireless phones. There is no proof, however, that wireless phones are absolutely safe. Wireless phones emit low levels of radiofrequency energy (RF) in the microwave range while being used. They also emit very low levels of RF when in the stand-by mode. Whereas high levels of RF can produce health effects (by heating tissue), exposure to low level RF that does not produce heating effects causes no known adverse health effects. Many studies of low level RF exposures have not found any biological effects. Some studies have suggested that some biological effects may occur, but such findings have not been confirmed by additional research. In some cases, other researchers have had difficulty in reproducing those studies, or in determining the reasons for inconsistent results.

2. What is FDA's role concerning the safety of wireless phones?

Under the law, FDA does not review the safety of radiation-emitting consumer products such as wireless phones before they can be sold, as it does with new drugs or medical devices. However, the agency has authority to take action if wireless phones are shown to emit radiofrequency energy (RF) at a level that is hazardous to the user. In such a case, FDA could require the manufacturers of wireless phones to notify users of the health hazard and to repair, replace or recall the phones so that the hazard no longer exists.

Although the existing scientific data do not justify FDA regulatory actions, FDA has urged the wireless phone industry to take a number of steps, including the following:

- Support needed research into possible biological effects of RF of the type emitted by wireless phones;
- Design wireless phones in a way that minimizes any RF exposure to the user that is not necessary for device function; and
- Cooperate in providing users of wireless phones with the best possible information on possible effects of wireless phone use on human health.

FDA belongs to an interagency working group of the federal agencies that have responsibility for different aspects of RF safety to ensure coordinated efforts at the federal level. The following agencies belong to this working group:

- National Institute for Occupational Safety and Health
- Environmental Protection Agency
- Federal Communications Commission
- Occupational Safety and Health Administration
- National Telecommunications and Information Administration

The National Institutes of Health participates in some interagency working group activities, as well.

FDA shares regulatory responsibilities for wireless phones with the Federal Communications Commission (FCC). All phones that are sold in the United States must comply with FCC safety guidelines that limit RF exposure. FCC relies on FDA and other health agencies for safety questions about wireless phones. FCC also

regulates the base stations that the wireless phone networks rely upon. While these base stations operate at higher power than do the wireless phones themselves, the RF exposures that people get from these base stations are typically thousands of times lower than those they can get from wireless phones. Base stations are thus not the subject of the safety questions discussed in this document.

3. What kinds of phones are the subject of this update?

The term wireless phone refers here to hand-held wireless phones with built-in antennas, often called cell mobile or PCS phones. These types of wireless phones can expose the user to measurable radiofrequency energy (RF) because of the short distance between the phone and the user's head. These RF exposures are limited by Federal Communications Commission safety guidelines that were developed with the advice of FDA and other federal health and safety agencies. When the phone is located at greater distances from the user, the exposure to RF is drastically lower because a person's RF exposure decreases rapidly with increasing distance from the source. The so-called cordless phones, which have a base unit connected to the telephone wiring in a house, typically operate at far lower power levels, and thus produce RF exposures far below the FCC safety limits.

4. What are the results of the research done already?

The research done thus far has produced conflicting results, and many studies have suffered from flaws in their research methods. Animal experiments investigating the effects of radiofrequency energy (RF) exposures characteristic of wireless phones have yielded conflicting results that often cannot be repeated in other laboratories. A few animal studies, however, have suggested that low levels of RF could accelerate the development of cancer in laboratory animals. However, many of the studies that showed increased tumor development used animals that had been genetically engineered or treated with cancer-causing chemicals so as to be pre-disposed to develop cancer in the absence of RF exposure. Other studies exposed the animals to RF for up to 22 hours per day. These conditions are not similar to the conditions under which people use wireless phones, so we don't know with certainty what the results of such studies mean for human health.

Three large epidemiology studies have been published since December 2000. Between them, the studies investigated any possible association between the use of wireless phones and primary brain cancer, glioma, meningioma, or acoustic neuroma, tumors of the brain or salivary gland, leukemia, or other cancers. None of the studies demonstrated the existence of any harmful health effects from wireless phone RF exposures. However, none of the studies can answer questions about long-term exposures, since the average period of phone use in these studies was around three years.

5. What research is needed to decide whether RF exposure from wireless phones poses a health risk?

A combination of laboratory studies and epidemiological studies of people actually using wireless phones would provide some of the data that are needed. Lifetime animal exposure studies could be completed in a few years. However, very large numbers of animals would be needed to provide reliable proof of a cancer promoting effect if one exists. Epidemiological studies can provide data that is directly applicable to human populations, but 10 or more years follow-up may be needed to provide answers about some health effects, such as cancer. This is because the interval

between the time of exposure to a cancer-causing agent and the time tumors develop - if they do - may be many, many years. The interpretation of epidemiological studies is hampered by difficulties in measuring actual RF exposure during day-to-day use of wireless phones. Many factors affect this measurement, such as the angle at which the phone is held, or which model of phone is used.

6. What is FDA doing to find out more about the possible health effects of wireless phone RF?

FDA is working with the U.S. National Toxicology Program and with groups of investigators around the world to ensure that high priority animal studies are conducted to address important questions about the effects of exposure to radiofrequency energy (RF).

FDA has been a leading participant in the World Health Organization International Electromagnetic Fields (EMF) Project since its inception in 1996. An influential result of this work has been the development of a detailed agenda of research needs that has driven the establishment of new research programs around the world. The Project has also helped develop a series of public information documents on EMF issues.

FDA and the Cellular Telecommunications & Internet Association (CTIA) have a formal Cooperative Research and Development Agreement (CRADA) to do research on wireless phone safety. FDA provides the scientific oversight, obtaining input from experts in government, industry, and academic organizations. CTIA-funded research is conducted through contracts to independent investigators. The initial research will include both laboratory studies and studies of wireless phone users. The CRADA will also include a broad assessment of additional research needs in the context of the latest research developments around the world.

7. How can I find out how much radiofrequency energy exposure I can get by using my wireless phone?

All phones sold in the United States must comply with Federal Communications Commission (FCC) guidelines that limit radiofrequency energy (RF) exposures. FCC established these guidelines in consultation with FDA and the other federal health and safety agencies. The FCC limit for RF exposure from wireless telephones is set at a Specific Absorption Rate (SAR) of 1.6 watts per kilogram (1.6 W/kg). The FCC limit is consistent with the safety standards developed by the Institute of Electrical and Electronic Engineering (IEEE) and the National Council on Radiation Protection and Measurement. The exposure limit takes into consideration the body's ability to remove heat from the tissues that absorb energy from the wireless phone and is set well below levels known to have effects.

Manufacturers of wireless phones must report the RF exposure level for each model of phone to the FCC. The FCC website (<http://www.fcc.gov/oet/rfsafety>) gives directions for locating the FCC identification number on your phone so you can find your phone's RF exposure level in the online listing.

8. What has FDA done to measure the radiofrequency energy coming from wireless phones?

The Institute of Electrical and Electronic Engineers (IEEE) is developing a technical standard for measuring the radiofrequency energy (RF) exposure from wireless phones and other wireless handsets with the participation and leadership of FDA scientists and engineers. The standard, Recommended Practice for Determining the

Spatial-Peak Specific Absorption Rate (SAR) in the Human Body Due to Wireless Communications Devices: Experimental Techniques, sets forth the first consistent test methodology for measuring the rate at which RF is deposited in the heads of wireless phone users. The test method uses a tissue-simulating model of the human head. Standardized SAR test methodology is expected to greatly improve the consistency of measurements made at different laboratories on the same phone. SAR is the measurement of the amount of energy absorbed in tissue, either by the whole body or a small part of the body. It is measured in watts/kg (or milliwatts/g) of matter. This measurement is used to determine whether a wireless phone complies with safety guidelines.

9. What steps can I take to reduce my exposure to radiofrequency energy from my wireless phone?

If there is a risk from these products--and at this point we do not know that there is--it is probably very small. But if you are concerned about avoiding even potential risks, you can take a few simple steps to minimize your exposure to radiofrequency energy (RF). Since time is a key factor in how much exposure a person receives, reducing the amount of time spent using a wireless phone will reduce RF exposure.

If you must conduct extended conversations by wireless phone every day, you could place more distance between your body and the source of the RF, since the exposure level drops off dramatically with distance. For example, you could use a headset and carry the wireless phone away from your body or use a wireless phone connected to a remote antenna.

Again, the scientific data do not demonstrate that wireless phones are harmful. But if you are concerned about the RF exposure from these products, you can use measures like those described above to reduce your RF exposure from wireless phone use.

10. What about children using wireless phones?

The scientific evidence does not show a danger to users of wireless phones, including children and teenagers. If you want to take steps to lower exposure to radiofrequency energy (RF), the measures described above would apply to children and teenagers using wireless phones. Reducing the time of wireless phone use and increasing the distance between the user and the RF source will reduce RF exposure. Some groups sponsored by other national governments have advised that children be discouraged from using wireless phones at all. For example, the government in the United Kingdom distributed leaflets containing such a recommendation in December 2000. They noted that no evidence exists that using a wireless phone causes brain tumors or other ill effects. Their recommendation to limit wireless phone use by children was strictly precautionary; it was not based on scientific evidence that any health hazard exists.

11. What about wireless phone interference with medical equipment?

Radiofrequency energy (RF) from wireless phones can interact with some electronic devices. For this reason, FDA helped develop a detailed test method to measure electromagnetic interference (EMI) of implanted cardiac pacemakers and defibrillators from wireless telephones. This test method is now part of a standard sponsored by the Association for the Advancement of Medical Instrumentation (AAMI). The final draft, a joint effort by FDA, medical device manufacturers, and many other groups, was completed in late 2000. This standard will allow manufacturers to ensure that cardiac pacemakers and defibrillators are safe from wireless phone EMI.

FDA has tested hearing aids for interference from handheld wireless phones and helped develop a voluntary standard sponsored by the Institute of Electrical and Electronic Engineers (IEEE). This standard specifies test methods and performance requirements for hearing aids and wireless phones so that no interference occurs when a person uses a compatible phone and a accompanied hearing aid at the same time. This standard was approved by the IEEE in 2000.

FDA continues to monitor the use of wireless phones for possible interactions with other medical devices. Should harmful interference be found to occur, FDA will conduct testing to assess the interference and work to resolve the problem.

12. Where can I find additional information?

For additional information, please refer to the following resources:

- FDA web page on wireless phones
<http://www.fda.gov/cdrh/phones/index.html>
- Federal Communications Commission (FCC) RF Safety Program
<http://www.fcc.gov/oet/rfsafety>
- International Commission on Non-Ionizing Radiation Protection
<http://www.icnirp.de>
- World Health Organization (WHO) International EMF Project
<http://www.who.int/emf>
- National Radiological Protection Board (UK)
<http://www.nrpb.org.uk/>

July 18, 2001 For updates: <http://www.fda.gov/cdrh/phones>

Index

Numerics

- 1-touch dialing
 - assign a number 40
 - delete a number 41

A

- active call options
 - answer a waiting call 43
 - end the active call 43
 - reject a waiting call 43
 - switch between calls 43
 - third call waiting 43
- alarm clock 100
 - delay alarm 100
 - snooze 100
- answer
 - a call 18
 - a waiting call 43
- antenna 13
- applications
 - check available memory 109
 - download 110
 - launch 109
- audible alerts 48
- authority certificates 86
- automatic keyguard 64

B

- back cover release 12
- battery
 - charge 10
 - check strength 14
 - indication on screen 14
 - power 14
- block

- international calls 68
- multimedia messages 79
- bookmarks 85
- browser options 83
- business cards
 - receive 101
 - send 101

C

- cache memory 85
- calculator 101
- calendar
 - make a note 98
 - navigate 98
 - view 98
- call timers 36
- call waiting 22, 43
- caller groups
 - add names 59
 - assign ringing tone 59
 - graphics 60
 - remove names 59
 - rename 59
- caller ID 18, 22
- check volume 14
- clock
 - 12 hour 55
 - 24 hour 55
 - alarm 100
 - display 55
 - hide 55
 - set 54
 - set time format 55
- code
 - default security code 67

- personal unblocking key 66
- PIN 65
- restriction password 65
- security code 65

conference calls 44

contacts

- delete entire contents 34
- delete names and numbers 33
- edit names and numbers 32
- find names 31

convert currency 102

covers, changing 60

D

data call history 38

date

- display 55
- hide 55
- set 55
- set format 55

disconnect from mobile Internet 88

display language 54

downloading ringing tones 53

E

e-mail

- send 74, 75
- set up sending profile 74

emergency call while online 88

end a call 17

end key 17

enhancements 112

F

file size 81

file type 81

fixed dialing 67

G

gallery

- add a folder 57
- delete a folder 57
- rename a folder 57
- view a folder 57

games 107

- Air Glide 107
- Backgammon 108
- Bowling 107
- Sky Diver 108

GPRS 82

- call history 35
- call while online 87
- check data call history 35
- phone symbols 86

H

handsfree operation 47

headset 11

help text 54

I

icons 14

idle screen 13

IM

- availability 91
- contacts 93
- conversations 91
- group chat 95
- log in 91
- log off 97
- offline menu 90
- online menu 90
- service provider icons 89
- settings 96

Indicators 14

information message service 81

international calls

- prefix 29
- restrict access 68

J

Java midlets 109

K

keyguard 64

L

line for outgoing calls 22

list of menus and submenus 19

lock codes

PIN codes 65

PUK codes 66

M

make

a call 17

an international call 40

emergency call while online 88

memory

available for multimedia messages
79

default memory for contacts 33

message settings

message center number 70

message mode 70

messages

check text messages 72

check voice mail 46

MIDI 53

midlets 109

MMS

advertisements 79

connection settings 79

delete a message 81

inbox 78

maximum size 79

play a sound clip 81

read a message 80

read a message later 80

reply to a message 81

ringing tone 78

save a received graphic 81

save a received ringing tone 81

sender information 81

settings 79

write and send a message 80

mobile Internet

connect 83

disconnect 88

empty the cache 85

navigate 83

security issues 85

site examples 84

N

network services 22

call forwarding 22, 41

call waiting 43

conference calls 44

outgoing line 41

system selection 43

transfer calls 44

Nokia Customer Care 7

O

onscreen help 54

P

phone

illustrated 1

keys for WAP browser 84

label 7

memory 32

symbols 14

picture messages

read 77

save 78

send 77

send with text 77

PIN code 66

polyphonic sound 53
predictive text

- activate 27
- add new words 28
- enter 27

profiles
customize 49
handsfree 50

PUK code 66

Q

quick guide 2

R

redial a call 18
reject a call 18
restrict calls 68

S

scroll bar 19
security code 65
default 67
security features
automatic keyguard 64
personal unblocking key 66
PIN code 66
prevent unauthorized use 66
PUK code 66
require password 66
send pause for touch tones 29
settings
accessory 50
display 58
MMS 79
restore factory 60
time and date 54
signal strength
check 17
indicator 14
SIM card

install 9
remove 11
start screen 13
stopwatch
delete times 104
stop the clock 104
view times 104
swap between two calls 43
synchronize contacts and calendar 105
system selection 22

T

talk key 17
text messages
copy to calendar 74
options 73
read 72
read later 73
send 72
send to multiple recipients 72
set up 70
use GPRS 71
to-do note 102
troubleshooting 122
TTY
end a call 53
make a call 53
receive a call 53

U

update date and time 55

V

voice commands 47
voice dialing
add a voice tag 46
change a voice tag 47
delete a voice tag 47
make a call with voice recognition
47

- play back a voice tag 47
- voice mail
 - listen to your messages 45
 - save the mailbox number 45
- volume 14
 - adjust 14
 - check level on screen 14
 - earpiece 14
 - keypad tones 49

W

- WAP browser 83
- WAP page
 - active link 84
 - enter information 84
 - examples 84
 - header line 84

X

- Xpress-on color cover 60

Para obtener un manual del usuario en español favor de llamar o enviar un fax al teléfono 1-888-NOKIA-2U, fax 813-249-9619.

Nokia 3595 User Guide 9230479